

Alphabets, Strings, and Languages

Alphabets and symbols

Definition: An *alphabet* is a finite, nonempty set of elements, which are called *symbols*.

Alphabets and symbols

Definition: An *alphabet* is a finite, nonempty set of elements, which are called *symbols*.

Example:

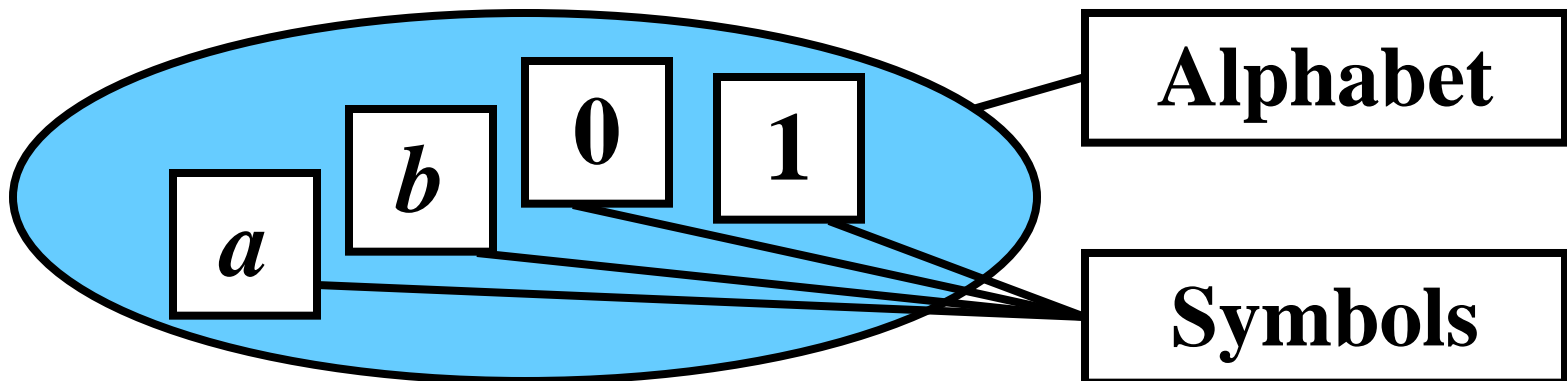

If we denote this alphabet as Σ , then $\Sigma = \{a, b, 0, 1\}$

String

Gist: $x = a_1a_2 \dots a_n$

Definition: Let Σ be an alphabet.

- 1) ε is a string over Σ
- 2) if x is a string over Σ and $a \in \Sigma$ then xa is a string over Σ

Note: ε denotes *the empty string* that contains no symbols.

Example: Consider $\Sigma = \{0, 1\}$:

String

Gist: $x = a_1a_2\cdots a_n$

Definition: Let Σ be an alphabet.

- 1) ε is a string over Σ
- 2) if x is a string over Σ and $a \in \Sigma$ then xa is a string over Σ

Note: ε denotes *the empty string* that contains no symbols.

Example: Consider $\Sigma = \{0, 1\}$:

ε

String

Gist: $x = a_1a_2\cdots a_n$

Definition: Let Σ be an alphabet.

1) ε is a string over Σ

2) if x is a string over Σ and $a \in \Sigma$ then xa is a string over Σ

Note: ε denotes *the empty string* that contains no symbols.

Example: Consider $\Sigma = \{0, 1\}$:

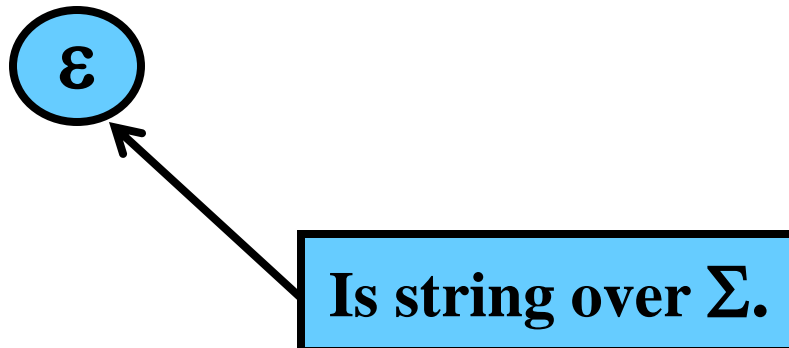

String

Gist: $x = a_1a_2\cdots a_n$

Definition: Let Σ be an alphabet.

- 1) ε is a string over Σ
- 2) if x is a string over Σ and $a \in \Sigma$ then xa is a string over Σ

Note: ε denotes *the empty string* that contains no symbols.

Example: Consider $\Sigma = \{0, 1\}$:

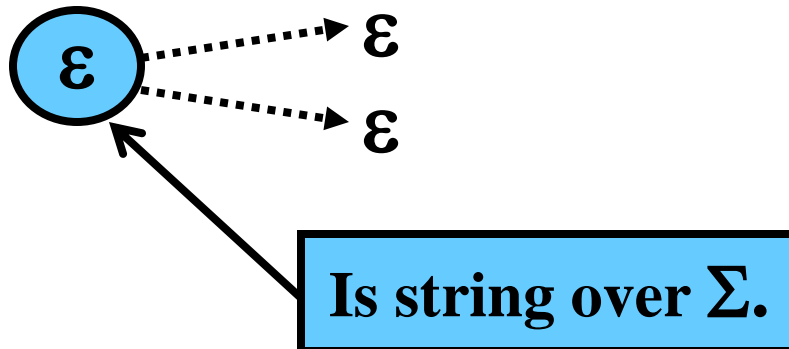

String

Gist: $x = a_1a_2 \dots a_n$

Definition: Let Σ be an alphabet.

1) ε is a string over Σ

2) if x is a string over Σ and $a \in \Sigma$ then xa is a string over Σ

Note: ε denotes *the empty string* that contains no symbols.

Example: Consider $\Sigma = \{0, 1\}$:

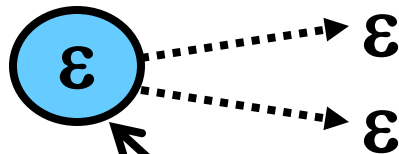

Is string over Σ .

Σ

String

Gist: $x = a_1a_2\dots a_n$

Definition: Let Σ be an alphabet.

- 1) ε is a string over Σ
- 2) if x is a string over Σ and $a \in \Sigma$ then xa is a string over Σ

Note: ε denotes *the empty string* that contains no symbols.

Example: Consider $\Sigma = \{0, 1\}$:

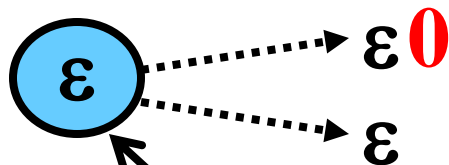

Is string over Σ .

Σ

String

Gist: $x = a_1a_2\dots a_n$

Definition: Let Σ be an alphabet.

- 1) ε is a string over Σ
- 2) if x is a string over Σ and $a \in \Sigma$ then xa is a string over Σ

Note: ε denotes *the empty string* that contains no symbols.

Example: Consider $\Sigma = \{0, 1\}$:

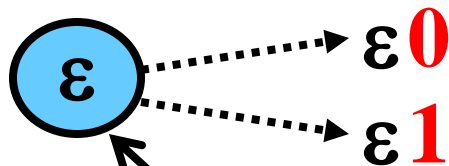

Is string over Σ .

Σ

String

Gist: $x = a_1a_2\cdots a_n$

Definition: Let Σ be an alphabet.

- 1) ε is a string over Σ
- 2) if x is a string over Σ and $a \in \Sigma$ then xa is a string over Σ

Note: ε denotes *the empty string* that contains no symbols.

Example: Consider $\Sigma = \{0, 1\}$:

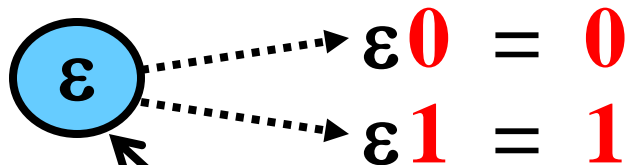

Is string over Σ .

Σ

String

Gist: $x = a_1a_2\dots a_n$

Definition: Let Σ be an alphabet.

- 1) ε is a string over Σ
- 2) if x is a string over Σ and $a \in \Sigma$ then xa is a string over Σ

Note: ε denotes *the empty string* that contains no symbols.

Example: Consider $\Sigma = \{0, 1\}$:

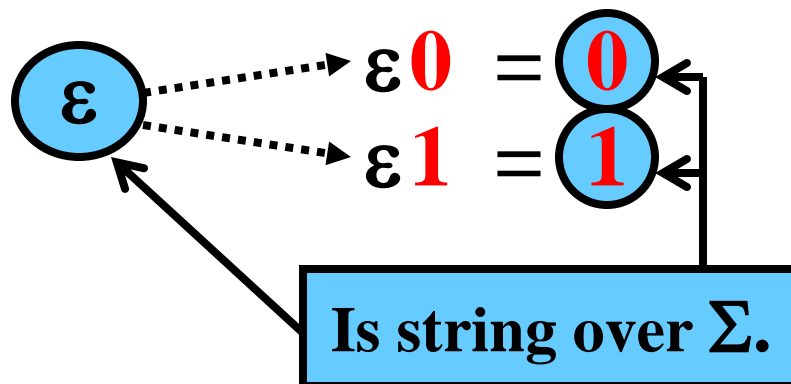

Σ

String

Gist: $x = a_1a_2 \dots a_n$

Definition: Let Σ be an alphabet.

1) ε is a string over Σ

2) if x is a string over Σ and $a \in \Sigma$ then xa is a string over Σ

Note: ε denotes *the empty string* that contains no symbols.

Example: Consider $\Sigma = \{0, 1\}$:

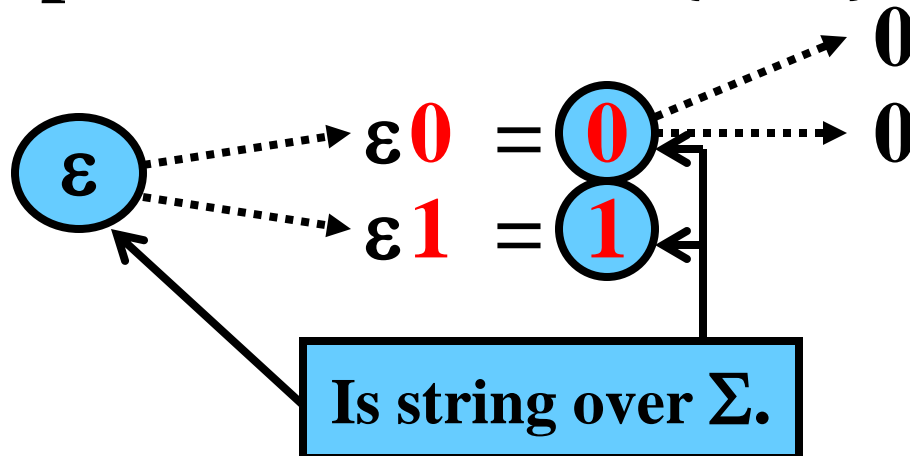

Σ

String

Gist: $x = a_1a_2 \dots a_n$

Definition: Let Σ be an alphabet.

1) ε is a string over Σ

2) if x is a string over Σ and $a \in \Sigma$ then xa is a string over Σ

Note: ε denotes *the empty string* that contains no symbols.

Example: Consider $\Sigma = \{0, 1\}$:

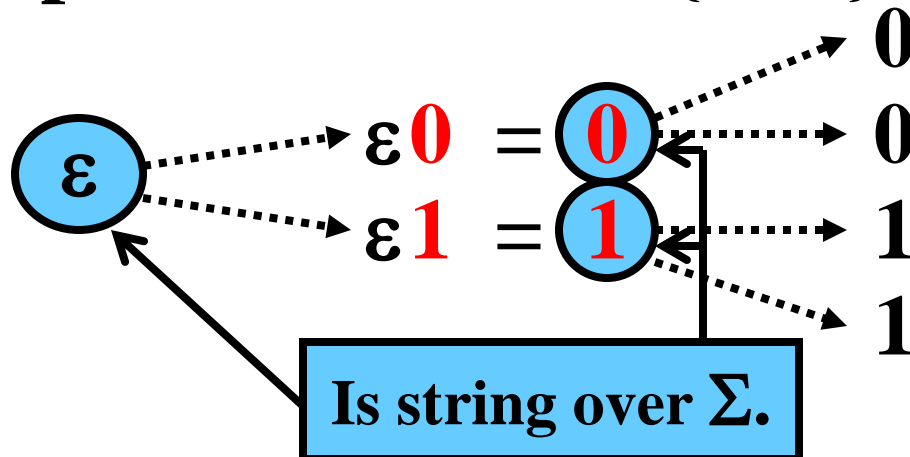

String

Gist: $x = a_1a_2 \dots a_n$

Definition: Let Σ be an alphabet.

1) ε is a string over Σ

2) if x is a string over Σ and $a \in \Sigma$ then xa is a string over Σ

Note: ε denotes *the empty string* that contains no symbols.

Example: Consider $\Sigma = \{0, 1\}$:

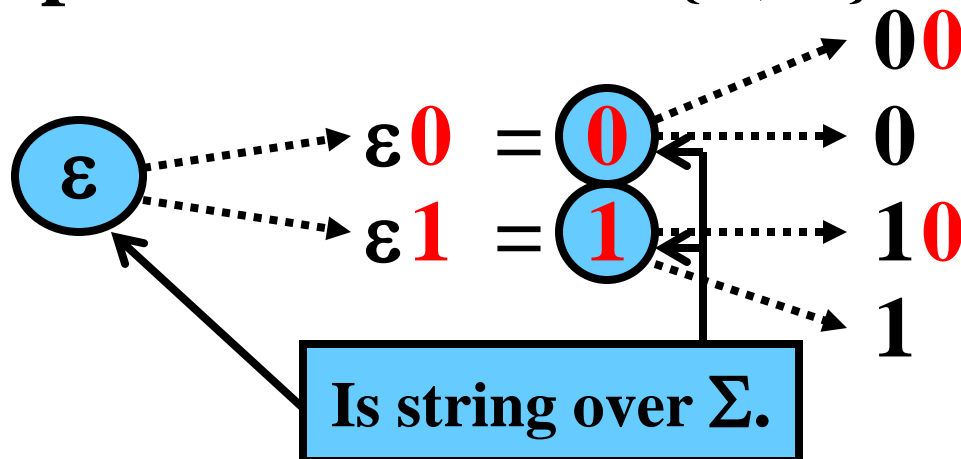

Σ

String

Gist: $x = a_1a_2\dots a_n$

Definition: Let Σ be an alphabet.

1) ε is a string over Σ

2) if x is a string over Σ and $a \in \Sigma$ then xa is a string over Σ

Note: ε denotes *the empty string* that contains no symbols.

Example: Consider $\Sigma = \{0, 1\}$:

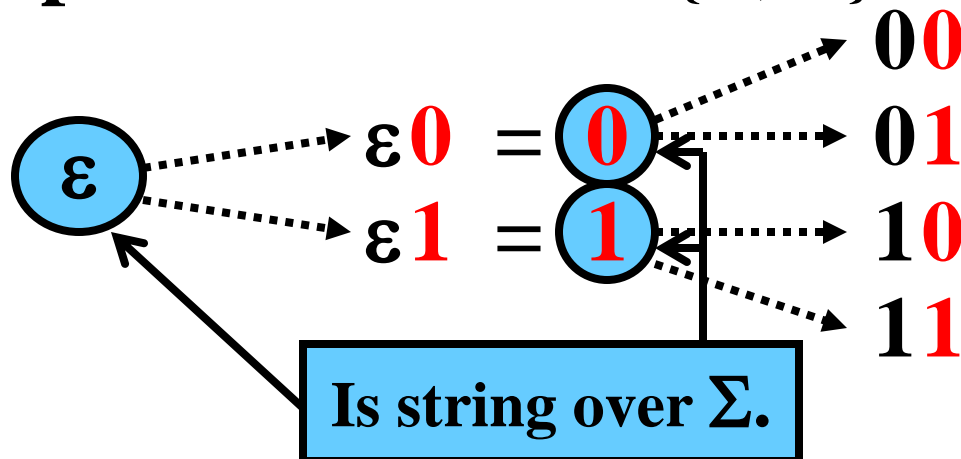

String

Gist: $x = a_1a_2\dots a_n$

Definition: Let Σ be an alphabet.

1) ε is a string over Σ

2) if x is a string over Σ and $a \in \Sigma$ then xa is a string over Σ

Note: ε denotes *the empty string* that contains no symbols.

Example: Consider $\Sigma = \{0, 1\}$:

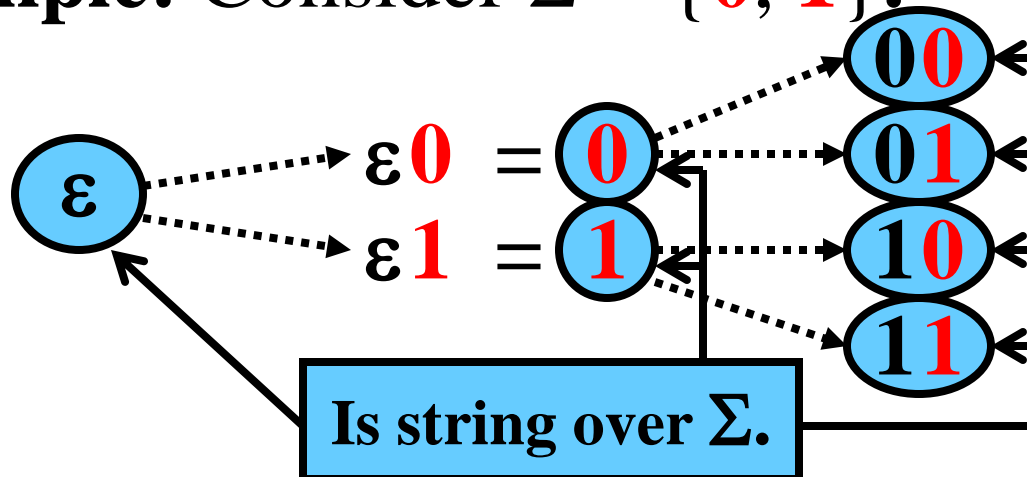

String

Gist: $x = a_1a_2 \dots a_n$

Definition: Let Σ be an alphabet.

- 1) ε is a string over Σ
- 2) if x is a string over Σ and $a \in \Sigma$ then xa is a string over Σ

Note: ε denotes *the empty string* that contains no symbols.

Example: Consider $\Sigma = \{0, 1\}$:

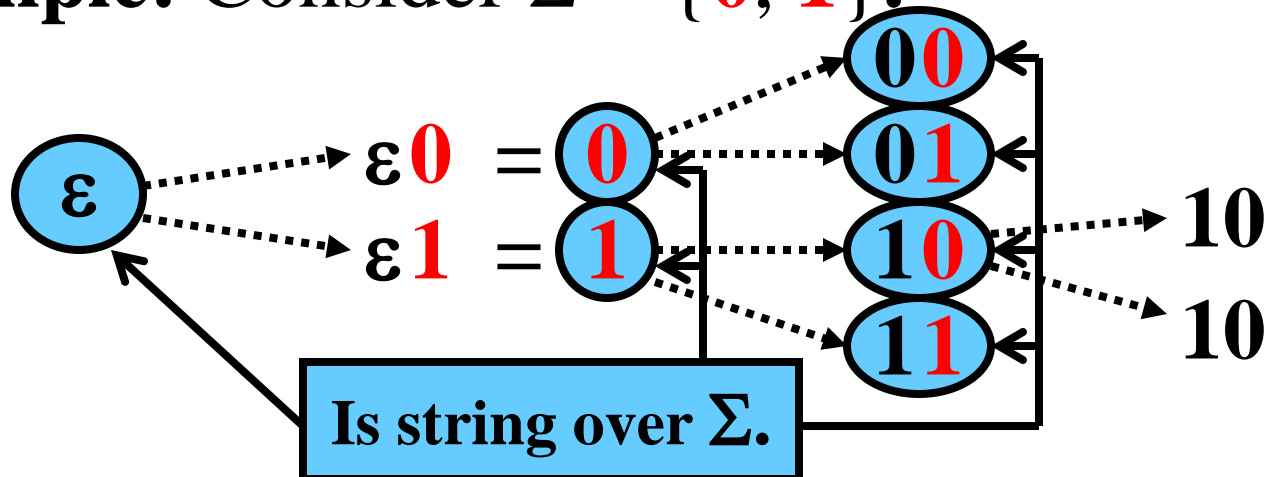

Σ

String

Gist: $x = a_1a_2 \dots a_n$

Definition: Let Σ be an alphabet.

1) ε is a string over Σ

2) if x is a string over Σ and $a \in \Sigma$ then xa is a string over Σ

Note: ε denotes *the empty string* that contains no symbols.

Example: Consider $\Sigma = \{0, 1\}$:

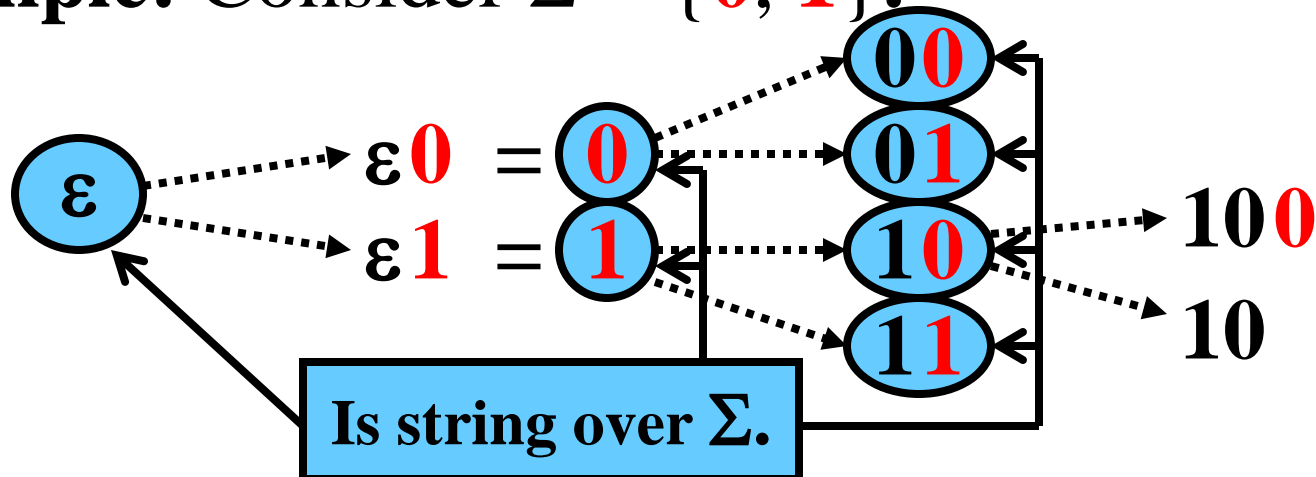

String

Gist: $x = a_1a_2\dots a_n$

Definition: Let Σ be an alphabet.

1) ε is a string over Σ

2) if x is a string over Σ and $a \in \Sigma$ then xa is a string over Σ

Note: ε denotes *the empty string* that contains no symbols.

Example: Consider $\Sigma = \{0, 1\}$:

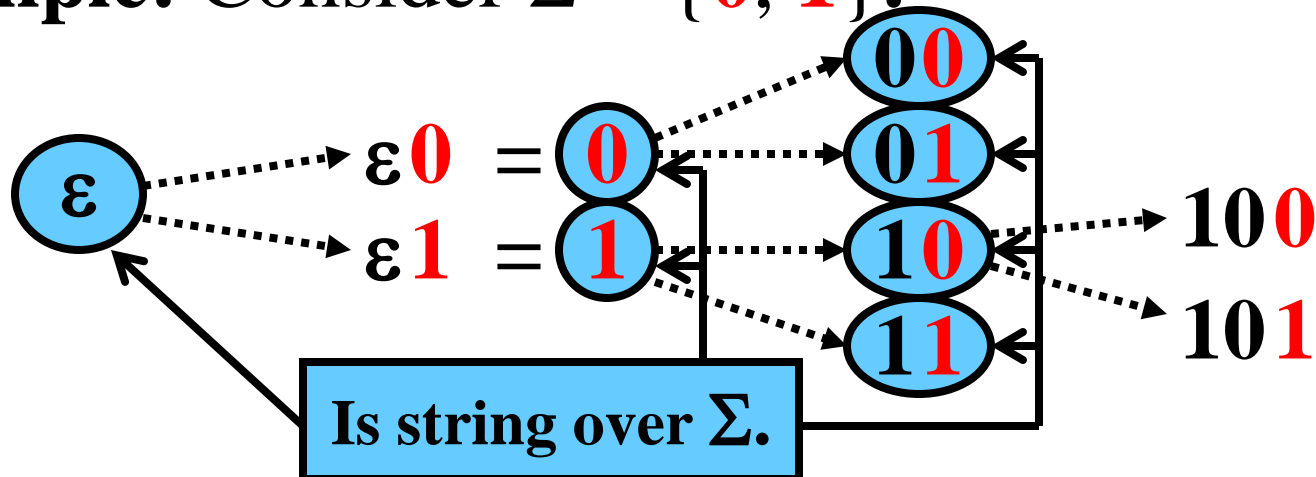

String

Gist: $x = a_1a_2\dots a_n$

Definition: Let Σ be an alphabet.

- 1) ε is a string over Σ
- 2) if x is a string over Σ and $a \in \Sigma$ then xa is a string over Σ

Note: ε denotes *the empty string* that contains no symbols.

Example: Consider $\Sigma = \{0, 1\}$:

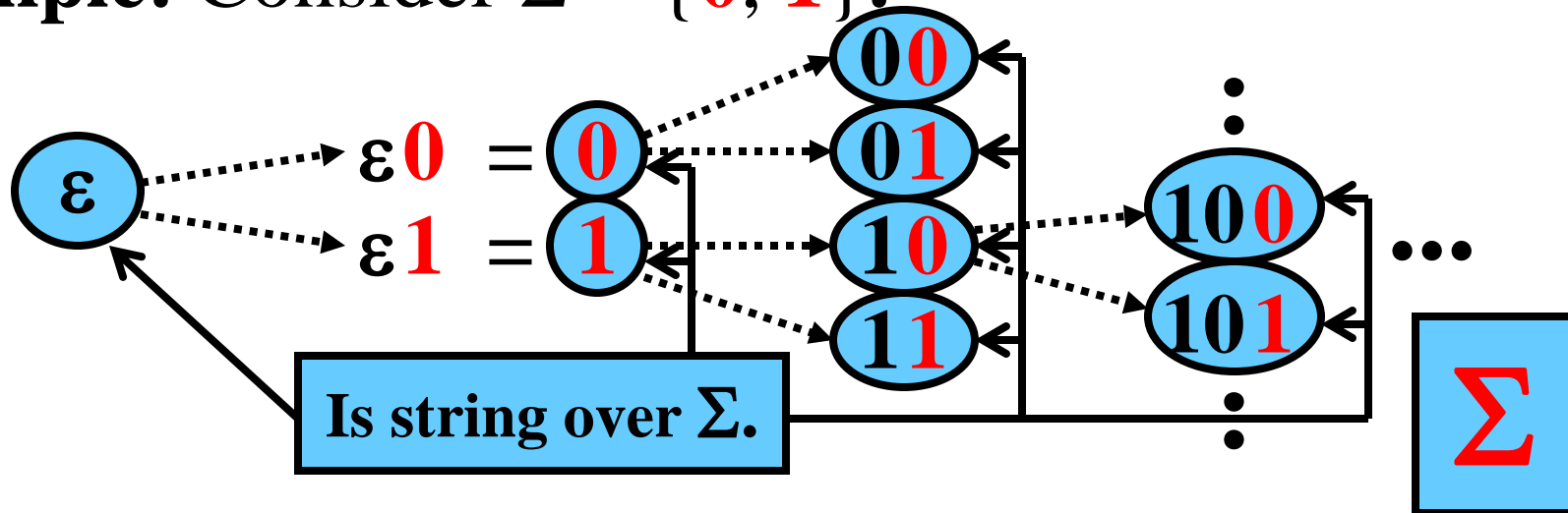

String

Gist: $x = a_1a_2\cdots a_n$

Definition: Let Σ be an alphabet.

- 1) ε is a string over Σ
- 2) if x is a string over Σ and $a \in \Sigma$ then xa is a string over Σ

Note: ε denotes *the empty string* that contains no symbols.

Example: Consider $\Sigma = \{0, 1\}$:

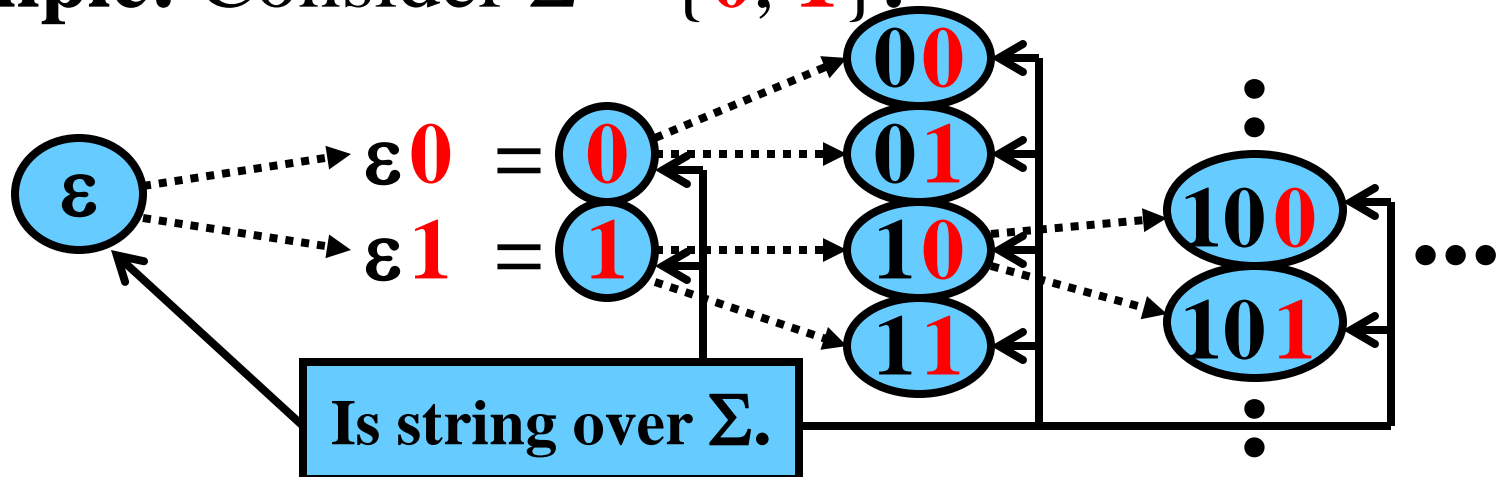

Length of String

Gist: $|a_1a_2\dots a_n| = n$

Definition: Let x be a string over Σ .

The *length* of x , $|x|$, is defined as follows:

1) if $x = \varepsilon$, then $|x| = 0$

2) if $x = a_1\dots a_n$, then $|x| = n$

for some $n \geq 1$, and $a_i \in \Sigma$ for all $i = 1, \dots, n$

Note: The length of x is the number of all symbols in x .

Example: Consider $x = 1010$

Task: $|x|$

Length of String

Gist: $|a_1a_2\dots a_n| = n$

Definition: Let x be a string over Σ .

The *length* of x , $|x|$, is defined as follows:

1) if $x = \varepsilon$, then $|x| = 0$

2) if $x = a_1\dots a_n$, then $|x| = n$

for some $n \geq 1$, and $a_i \in \Sigma$ for all $i = 1, \dots, n$

Note: The length of x is the number of all symbols in x .

Example: Consider $x = 1010$

Task: $|x|$

$x = 1\ 0\ 1\ 0$

Length of String

Gist: $|a_1a_2\dots a_n| = n$

Definition: Let x be a string over Σ .

The *length* of x , $|x|$, is defined as follows:

1) if $x = \varepsilon$, then $|x| = 0$

2) if $x = a_1\dots a_n$, then $|x| = n$

for some $n \geq 1$, and $a_i \in \Sigma$ for all $i = 1, \dots, n$

Note: The length of x is the number of all symbols in x .

Example: Consider $x = 1010$

Task: $|x|$

$$\begin{array}{cccc}
 \mathbf{x} & = & \mathbf{1} & \mathbf{0} & \mathbf{1} & \mathbf{0} \\
 & & \mathbf{a}_1 & \mathbf{a}_2 & \mathbf{a}_3 & \mathbf{a}_4
 \end{array}$$

Length of String

Gist: $|a_1a_2\dots a_n| = n$

Definition: Let x be a string over Σ .

The *length* of x , $|x|$, is defined as follows:

1) if $x = \varepsilon$, then $|x| = 0$

2) if $x = a_1\dots a_n$, then $|x| = n$

for some $n \geq 1$, and $a_i \in \Sigma$ for all $i = 1, \dots, n$

Note: The length of x is the number of all symbols in x .

Example: Consider $x = 1010$

Task: $|x|$

$x = 1\ 0\ 1\ 0$

$a_1 a_2 a_3 a_4 \rightarrow n = 4$, thus $|x| = 4$

Concatenation of Strings

Gist: xy

Definition: Let x and y be two strings over Σ .
The *concatenation* of x and y is xy .

Note: $x\varepsilon = \varepsilon x = x$

Concatenation of Strings

Gist: xy

Definition: Let x and y be two strings over Σ .
The *concatenation* of x and y is xy .

Note: $x\varepsilon = \varepsilon x = x$

Examples:

Concatenation of **101** and **001** is **101001**

Concatenation of **ε** and **001** is **$\varepsilon 001 = 001$**

Power of String

Gist: $x^i = \underbrace{xx\dots x}_{i\text{-times}}$

Definition: Let x be a string over Σ .

For $i \geq 0$, the i -th *power* of x , x^i , is defined as

1) $x^0 = \varepsilon$ 2) if $i \geq 1$ then $x^i = xx^{i-1}$

Note: $x^i x^j = x^j x^i = x^{i+j}$, where $i, j \geq 0$

Example: Consider $x = 10$

Task: x^3

Power of String

Gist: $x^i = \underbrace{xx\dots x}_{i\text{-times}}$

Definition: Let x be a string over Σ .

For $i \geq 0$, the i -th *power* of x , x^i , is defined as

1) $x^0 = \varepsilon$ 2) if $i \geq 1$ then $x^i = xx^{i-1}$

Note: $x^i x^j = x^j x^i = x^{i+j}$, where $i, j \geq 0$

Example: Consider $x = 10$

Task: x^3

$$x^3 = xx^2 = \mathbf{10}x^2$$

Power of String

Gist: $x^i = \underbrace{xx\dots x}_{i\text{-times}}$

Definition: Let x be a string over Σ .

For $i \geq 0$, the i -th *power* of x , x^i , is defined as

1) $x^0 = \varepsilon$ 2) if $i \geq 1$ then $x^i = xx^{i-1}$

Note: $x^i x^j = x^j x^i = x^{i+j}$, where $i, j \geq 0$

Example: Consider $x = 10$

Task: x^3

$$\curvearrowright x^3 = xx^2 = \mathbf{10}x^2$$

Power of String

Gist: $x^i = \underbrace{xx\dots x}_{i\text{-times}}$

Definition: Let x be a string over Σ .

For $i \geq 0$, the i -th *power* of x , x^i , is defined as

1) $x^0 = \varepsilon$ 2) if $i \geq 1$ then $x^i = xx^{i-1}$

Note: $x^i x^j = x^j x^i = x^{i+j}$, where $i, j \geq 0$

Example: Consider $x = 10$

Task: x^3

$$\begin{aligned} x^3 &= xx^2 = \mathbf{10}x^2 \\ &\curvearrowright x^2 = xx^1 = \mathbf{10}x^1 \end{aligned}$$

Power of String

Gist: $x^i = \underbrace{xx\dots x}_{i\text{-times}}$

Definition: Let x be a string over Σ .

For $i \geq 0$, the i -th *power* of x , x^i , is defined as

1) $x^0 = \varepsilon$ 2) if $i \geq 1$ then $x^i = xx^{i-1}$

Note: $x^i x^j = x^j x^i = x^{i+j}$, where $i, j \geq 0$

Example: Consider $x = 10$

Task: x^3

$$x^3 = xx^2 = \mathbf{10}x^2$$

$$x^2 = xx^1 = \mathbf{10}x^1$$

Power of String

Gist: $x^i = \underbrace{xx\dots x}_{i\text{-times}}$

Definition: Let x be a string over Σ .

For $i \geq 0$, the i -th *power* of x , x^i , is defined as

1) $x^0 = \varepsilon$ 2) if $i \geq 1$ then $x^i = xx^{i-1}$

Note: $x^i x^j = x^j x^i = x^{i+j}$, where $i, j \geq 0$

Example: Consider $x = 10$

Task: x^3

$$\begin{aligned}
 & \xrightarrow{\text{red arrow}} x^3 = xx^2 = \mathbf{10}x^2 \\
 & \xrightarrow{\text{red arrow}} x^2 = xx^1 = \mathbf{10}x^1 \\
 & \xrightarrow{\text{red arrow}} x^1 = xx^0 = \mathbf{10}x^0
 \end{aligned}$$

Power of String

Gist: $x^i = \underbrace{xx\dots x}_{i\text{-times}}$

Definition: Let x be a string over Σ .

For $i \geq 0$, the i -th *power* of x , x^i , is defined as

1) $x^0 = \varepsilon$ 2) if $i \geq 1$ then $x^i = xx^{i-1}$

Note: $x^i x^j = x^j x^i = x^{i+j}$, where $i, j \geq 0$

Example: Consider $x = 10$

Task: x^3

$$\begin{aligned}
 x^3 &= xx^2 = \mathbf{10}x^2 \\
 &\quad \swarrow \\
 x^2 &= xx^1 = \mathbf{10}x^1 \\
 &\quad \swarrow \\
 x^1 &= xx^0 = \mathbf{10}x^0
 \end{aligned}$$

Power of String

Gist: $x^i = \underbrace{xx\dots x}_{i\text{-times}}$

Definition: Let x be a string over Σ .

For $i \geq 0$, the i -th *power* of x , x^i , is defined as

1) $x^0 = \varepsilon$ 2) if $i \geq 1$ then $x^i = xx^{i-1}$

Note: $x^i x^j = x^j x^i = x^{i+j}$, where $i, j \geq 0$

Example: Consider $x = 10$

Task: x^3

$$\begin{aligned}
 & x^3 = xx^2 = \mathbf{10}x^2 \\
 & \quad x^2 = xx^1 = \mathbf{10}x^1 \\
 & \quad \quad x^1 = xx^0 = \mathbf{10}x^0 \\
 & \quad \quad \quad x^0 = \mathbf{\varepsilon}
 \end{aligned}$$

Power of String

Gist: $x^i = \underbrace{xx\dots x}_{i\text{-times}}$

Definition: Let x be a string over Σ .

For $i \geq 0$, the i -th *power* of x , x^i , is defined as

1) $x^0 = \varepsilon$ 2) if $i \geq 1$ then $x^i = xx^{i-1}$

Note: $x^i x^j = x^j x^i = x^{i+j}$, where $i, j \geq 0$

Example: Consider $x = 10$

Task: x^3

$$\begin{aligned}
 x^3 &= xx^2 = \mathbf{10}x^2 \\
 &\quad \curvearrowright \\
 x^2 &= xx^1 = \mathbf{10}x^1 \\
 &\quad \curvearrowright \\
 x^1 &= xx^0 = \mathbf{10}x^0 \\
 &\quad \curvearrowright \\
 x^0 &= \mathbf{\varepsilon} \quad \curvearrowright
 \end{aligned}$$

Power of String

Gist: $x^i = \underbrace{xx\dots x}_{i\text{-times}}$

Definition: Let x be a string over Σ .

For $i \geq 0$, the i -th *power* of x , x^i , is defined as

1) $x^0 = \varepsilon$ 2) if $i \geq 1$ then $x^i = xx^{i-1}$

Note: $x^ix^j = x^jx^i = x^{i+j}$, where $i, j \geq 0$

Example: Consider $x = 10$

Task: x^3

$$\begin{array}{l} x^3 = xx^2 = 10x^2 \\ x^2 = xx^1 = 10x^1 \\ x^1 = xx^0 = 10x^0 \\ x^0 = \varepsilon \end{array}$$

Power of String

Gist: $x^i = \underbrace{xx\dots x}_{i\text{-times}}$

Definition: Let x be a string over Σ .

For $i \geq 0$, the i -th *power* of x , x^i , is defined as

1) $x^0 = \varepsilon$ 2) if $i \geq 1$ then $x^i = xx^{i-1}$

Note: $x^i x^j = x^j x^i = x^{i+j}$, where $i, j \geq 0$

Example: Consider $x = 10$

Task: x^3

$$\begin{array}{l} x^3 = xx^2 = \mathbf{10}x^2 \\ x^2 = xx^1 = \mathbf{10}x^1 \\ x^1 = xx^0 = \mathbf{10}x^0 \longrightarrow x^1 = \mathbf{10}\varepsilon = \mathbf{10} \\ x^0 = \varepsilon \end{array}$$

Power of String

Gist: $x^i = \underbrace{xx\dots x}_{i\text{-times}}$

Definition: Let x be a string over Σ .

For $i \geq 0$, the i -th *power* of x , x^i , is defined as

1) $x^0 = \varepsilon$ 2) if $i \geq 1$ then $x^i = xx^{i-1}$

Note: $x^i x^j = x^j x^i = x^{i+j}$, where $i, j \geq 0$

Example: Consider $x = 10$

Task: x^3

$$\begin{array}{l}
 x^3 = xx^2 = \mathbf{10}x^2 \\
 x^2 = xx^1 = \mathbf{10}x^1 \\
 x^1 = xx^0 = \mathbf{10}x^0 \\
 x^0 = \mathbf{\varepsilon}
 \end{array}
 \qquad
 \begin{array}{l}
 \xrightarrow{\text{red arrow}} x^1 = \mathbf{10\varepsilon} = \mathbf{10}
 \end{array}$$

Power of String

Gist: $x^i = \underbrace{xx\dots x}_{i\text{-times}}$

Definition: Let x be a string over Σ .

For $i \geq 0$, the i -th *power* of x , x^i , is defined as

1) $x^0 = \varepsilon$ 2) if $i \geq 1$ then $x^i = xx^{i-1}$

Note: $x^i x^j = x^j x^i = x^{i+j}$, where $i, j \geq 0$

Example: Consider $x = 10$

Task: x^3

$$\begin{array}{l}
 x^3 = xx^2 = \mathbf{10}x^2 \\
 x^2 = xx^1 = \mathbf{10}x^1 \\
 x^1 = xx^0 = \mathbf{10}x^0 \\
 x^0 = \mathbf{\varepsilon}
 \end{array}
 \qquad
 \begin{array}{l}
 \xrightarrow{\hspace{1.5cm}} \\
 \xrightarrow{\hspace{1.5cm}} \\
 \xrightarrow{\hspace{1.5cm}} \\
 \xrightarrow{\hspace{1.5cm}}
 \end{array}
 \qquad
 \begin{array}{l}
 x^1 = \mathbf{10\varepsilon} = \mathbf{10}
 \end{array}$$

Power of String

Gist: $x^i = \underbrace{xx\dots x}_{i\text{-times}}$

Definition: Let x be a string over Σ .

For $i \geq 0$, the i -th *power* of x , x^i , is defined as

1) $x^0 = \varepsilon$ 2) if $i \geq 1$ then $x^i = xx^{i-1}$

Note: $x^i x^j = x^j x^i = x^{i+j}$, where $i, j \geq 0$

Example: Consider $x = 10$

Task: x^3

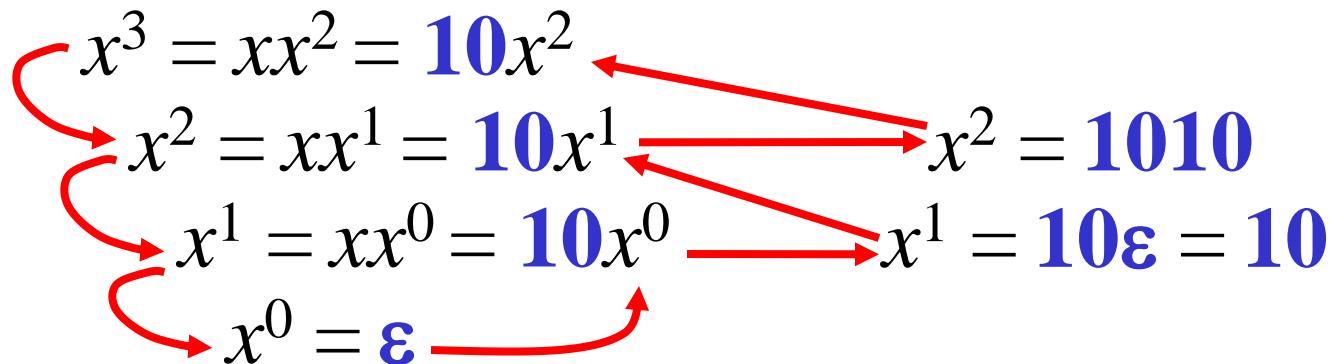

Power of String

Gist: $x^i = \underbrace{xx\dots x}_{i\text{-times}}$

Definition: Let x be a string over Σ .

For $i \geq 0$, the i -th *power* of x , x^i , is defined as

1) $x^0 = \varepsilon$ 2) if $i \geq 1$ then $x^i = xx^{i-1}$

Note: $x^i x^j = x^j x^i = x^{i+j}$, where $i, j \geq 0$

Example: Consider $x = 10$

Task: x^3

$$\begin{array}{l}
 x^3 = xx^2 = \mathbf{10}x^2 \\
 x^2 = xx^1 = \mathbf{10}x^1 \\
 x^1 = xx^0 = \mathbf{10}x^0 \\
 x^0 = \mathbf{\varepsilon}
 \end{array}
 \qquad
 \begin{array}{l}
 \xrightarrow{\hspace{1.5cm}} \\
 \xrightarrow{\hspace{1.5cm}} x^2 = \mathbf{1010} \\
 \xrightarrow{\hspace{1.5cm}} x^1 = \mathbf{10\varepsilon} = \mathbf{10} \\
 \xrightarrow{\hspace{1.5cm}}
 \end{array}$$

Power of String

Gist: $x^i = \underbrace{xx\dots x}_{i\text{-times}}$

Definition: Let x be a string over Σ .

For $i \geq 0$, the i -th *power* of x , x^i , is defined as

1) $x^0 = \varepsilon$ 2) if $i \geq 1$ then $x^i = xx^{i-1}$

Note: $x^i x^j = x^j x^i = x^{i+j}$, where $i, j \geq 0$

Example: Consider $x = 10$

Task: x^3

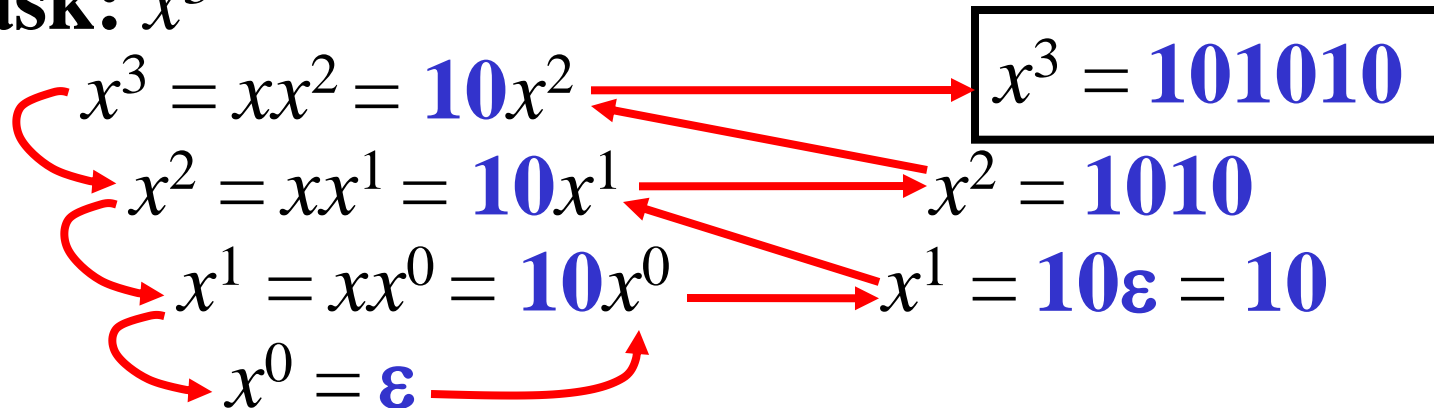

Reversal of String

Gist: $\text{reversal}(a_1 \dots a_n) = a_n \dots a_1$

Definition: Let x be a string over Σ .

The *reversal* of x , $\text{reversal}(x)$, is defined as:

- 1) if $x = \varepsilon$ then $\text{reversal}(\varepsilon) = \varepsilon$
- 2) if $x = a_1 \dots a_n$ then $\text{reversal}(a_1 \dots a_n) = a_n \dots a_1$
for some $n \geq 1$, and $a_i \in \Sigma$ for all $i = 1, \dots, n$

Example: Consider $x = 1010$

Task: $\text{reversal}(x)$

Reversal of String

Gist: $\text{reversal}(a_1 \dots a_n) = a_n \dots a_1$

Definition: Let x be a string over Σ .

The *reversal* of x , $\text{reversal}(x)$, is defined as:

- 1) if $x = \varepsilon$ then $\text{reversal}(\varepsilon) = \varepsilon$
- 2) if $x = a_1 \dots a_n$ then $\text{reversal}(a_1 \dots a_n) = a_n \dots a_1$
for some $n \geq 1$, and $a_i \in \Sigma$ for all $i = 1, \dots, n$

Example: Consider $x = 1010$

Task: $\text{reversal}(x)$

$\text{reversal}(1010) = 0101$, so

Reversal of String

Gist: $\text{reversal}(a_1 \dots a_n) = a_n \dots a_1$

Definition: Let x be a string over Σ .

The *reversal* of x , $\text{reversal}(x)$, is defined as:

- 1) if $x = \varepsilon$ then $\text{reversal}(\varepsilon) = \varepsilon$
- 2) if $x = a_1 \dots a_n$ then $\text{reversal}(a_1 \dots a_n) = a_n \dots a_1$
for some $n \geq 1$, and $a_i \in \Sigma$ for all $i = 1, \dots, n$

Example: Consider $x = 1010$

Task: $\text{reversal}(x)$

$\text{reversal}(a_1 \dots a_n) = a_n \dots a_1$, so

Reversal of String

Gist: $\text{reversal}(a_1 \dots a_n) = a_n \dots a_1$

Definition: Let x be a string over Σ .

The *reversal* of x , $\text{reversal}(x)$, is defined as:

- 1) if $x = \varepsilon$ then $\text{reversal}(\varepsilon) = \varepsilon$
- 2) if $x = a_1 \dots a_n$ then $\text{reversal}(a_1 \dots a_n) = a_n \dots a_1$
for some $n \geq 1$, and $a_i \in \Sigma$ for all $i = 1, \dots, n$

Example: Consider $x = 1010$

Task: $\text{reversal}(x)$

$$\text{reversal}(a_1 a_2) = a_2 a_1, \text{ so}$$

Reversal of String

Gist: $\text{reversal}(a_1 \dots a_n) = a_n \dots a_1$

Definition: Let x be a string over Σ .

The *reversal* of x , $\text{reversal}(x)$, is defined as:

1) if $x = \varepsilon$ then $\text{reversal}(\varepsilon) = \varepsilon$

2) if $x = a_1 \dots a_n$ then $\text{reversal}(a_1 \dots a_n) = a_n \dots a_1$
for some $n \geq 1$, and $a_i \in \Sigma$ for all $i = 1, \dots, n$

Example: Consider $x = 1010$

Task: $\text{reversal}(x)$

$$\text{reversal}(a_1 a_2 a_3) = a_3 a_2 a_1, \text{ so}$$

Reversal of String

Gist: $\text{reversal}(a_1 \dots a_n) = a_n \dots a_1$

Definition: Let x be a string over Σ .

The *reversal* of x , $\text{reversal}(x)$, is defined as:

- 1) if $x = \varepsilon$ then $\text{reversal}(\varepsilon) = \varepsilon$
- 2) if $x = a_1 \dots a_n$ then $\text{reversal}(a_1 \dots a_n) = a_n \dots a_1$
for some $n \geq 1$, and $a_i \in \Sigma$ for all $i = 1, \dots, n$

Example: Consider $x = 1010$

Task: $\text{reversal}(x)$

$$\text{reversal}(a_1 a_2 a_3 a_4) = a_4 a_3 a_2 a_1, \text{ so}$$

Reversal of String

Gist: $\text{reversal}(a_1 \dots a_n) = a_n \dots a_1$

Definition: Let x be a string over Σ .

The *reversal* of x , $\text{reversal}(x)$, is defined as:

- 1) if $x = \varepsilon$ then $\text{reversal}(\varepsilon) = \varepsilon$
- 2) if $x = a_1 \dots a_n$ then $\text{reversal}(a_1 \dots a_n) = a_n \dots a_1$
for some $n \geq 1$, and $a_i \in \Sigma$ for all $i = 1, \dots, n$

Example: Consider $x = 1010$

Task: $\text{reversal}(x)$

$$\text{reversal}(a_1 a_2 a_3 a_4) = a_4 a_3 a_2 a_1, \text{ so}$$

$$\text{reversal}(\quad) =$$

Reversal of String

Gist: $\text{reversal}(a_1 \dots a_n) = a_n \dots a_1$

Definition: Let x be a string over Σ .

The *reversal* of x , $\text{reversal}(x)$, is defined as:

- 1) if $x = \varepsilon$ then $\text{reversal}(\varepsilon) = \varepsilon$
- 2) if $x = a_1 \dots a_n$ then $\text{reversal}(a_1 \dots a_n) = a_n \dots a_1$
for some $n \geq 1$, and $a_i \in \Sigma$ for all $i = 1, \dots, n$

Example: Consider $x = 1010$

Task: $\text{reversal}(x)$

$$\text{reversal}(a_1 a_2 a_3 a_4) = a_4 a_3 a_2 a_1, \text{ so}$$

$$\text{reversal}(1010) = 0101$$

Reversal of String

Gist: $\text{reversal}(a_1 \dots a_n) = a_n \dots a_1$

Definition: Let x be a string over Σ .

The *reversal* of x , $\text{reversal}(x)$, is defined as:

- 1) if $x = \varepsilon$ then $\text{reversal}(\varepsilon) = \varepsilon$
- 2) if $x = a_1 \dots a_n$ then $\text{reversal}(a_1 \dots a_n) = a_n \dots a_1$
for some $n \geq 1$, and $a_i \in \Sigma$ for all $i = 1, \dots, n$

Example: Consider $x = 1010$

Task: $\text{reversal}(x)$

$\text{reversal}(a_1 a_2 a_3 a_4) = a_4 a_3 a_2 a_1$, so

$\text{reversal}(1\ 0\ 1\ 0) = 0\ 1\ 0\ 1$

Reversal of String

Gist: $\text{reversal}(a_1 \dots a_n) = a_n \dots a_1$

Definition: Let x be a string over Σ .

The *reversal* of x , $\text{reversal}(x)$, is defined as:

- 1) if $x = \varepsilon$ then $\text{reversal}(\varepsilon) = \varepsilon$
- 2) if $x = a_1 \dots a_n$ then $\text{reversal}(a_1 \dots a_n) = a_n \dots a_1$
for some $n \geq 1$, and $a_i \in \Sigma$ for all $i = 1, \dots, n$

Example: Consider $x = 1010$

Task: $\text{reversal}(x)$

$\text{reversal}(a_1 a_2 a_3 a_4) = a_4 a_3 a_2 a_1$, so

$\text{reversal}(1010) = 0101$

Reversal of String

Gist: $\text{reversal}(a_1 \dots a_n) = a_n \dots a_1$

Definition: Let x be a string over Σ .

The *reversal* of x , $\text{reversal}(x)$, is defined as:

- 1) if $x = \varepsilon$ then $\text{reversal}(\varepsilon) = \varepsilon$
- 2) if $x = a_1 \dots a_n$ then $\text{reversal}(a_1 \dots a_n) = a_n \dots a_1$
for some $n \geq 1$, and $a_i \in \Sigma$ for all $i = 1, \dots, n$

Example: Consider $x = 1010$

Task: $\text{reversal}(x)$

$\text{reversal}(a_1 a_2 a_3 a_4) = a_4 a_3 a_2 a_1$, so

$\text{reversal}(1\ 0\ 1\ 0) = 0\ 1\ 0\ 1$

Prefix of String

Gist: x is a prefix of xz

Definition: Let x and y be two strings over Σ ; x is *prefix* of y if there is a string z over Σ so

$$xz = y$$

Note: if $x \notin \{\varepsilon, y\}$ then x is *proper prefix* of y .

Example: Consider 1010

Task: All prefixes of **1010**

Prefix of String

Gist: x is a prefix of xz

Definition: Let x and y be two strings over Σ ; x is *prefix* of y if there is a string z over Σ so

$$xz = y$$

Note: if $x \notin \{\varepsilon, y\}$ then x is *proper prefix* of y .

Example: Consider 1010

Task: All prefixes of **1010**

ε

Prefix of String

Gist: x is a prefix of xz

Definition: Let x and y be two strings over Σ ; x is *prefix* of y if there is a string z over Σ so

$$xz = y$$

Note: if $x \notin \{\varepsilon, y\}$ then x is *proper prefix* of y .

Example: Consider 1010

Task: All prefixes of **1010**

ε
1

Prefix of String

Gist: x is a prefix of xz

Definition: Let x and y be two strings over Σ ; x is *prefix* of y if there is a string z over Σ so

$$xz = y$$

Note: if $x \notin \{\varepsilon, y\}$ then x is *proper prefix* of y .

Example: Consider 1010

Task: All prefixes of **1010**

ε
1
10

Prefix of String

Gist: x is a prefix of xz

Definition: Let x and y be two strings over Σ ; x is *prefix* of y if there is a string z over Σ so

$$xz = y$$

Note: if $x \notin \{\varepsilon, y\}$ then x is *proper prefix* of y .

Example: Consider 1010

Task: All prefixes of **1010**

ε
1
10
101

Prefix of String

Gist: x is a prefix of xz

Definition: Let x and y be two strings over Σ ; x is *prefix* of y if there is a string z over Σ so

$$xz = y$$

Note: if $x \notin \{\varepsilon, y\}$ then x is *proper prefix* of y .

Example: Consider 1010

Task: All prefixes of **1010**

ε
1
10
101
1010

Prefix of String

Gist: x is a prefix of xz

Definition: Let x and y be two strings over Σ ; x is *prefix* of y if there is a string z over Σ so
$$xz = y$$

Note: if $x \notin \{\varepsilon, y\}$ then x is *proper prefix* of y .

Example: Consider 1010

Task: All prefixes of **1010**

Prefixes of 1010



- ε
- 1
- 10
- 101
- 1010

Prefix of String

Gist: x is a prefix of xz

Definition: Let x and y be two strings over Σ ; x is *prefix* of y if there is a string z over Σ so

$$xz = y$$

Note: if $x \notin \{\varepsilon, y\}$ then x is *proper prefix* of y .

Example: Consider 1010

Task: All prefixes of **1010**

Prefixes of **1010** $\left\{ \begin{array}{l} \varepsilon \\ 1 \\ 10 \\ 101 \\ 1010 \end{array} \right\}$ Proper prefixes
of **1010**

Suffix of String

Gist: x is a suffix of zx

Definition: Let x and y be two strings over Σ ; x is *suffix* of y if there is a string z over Σ so

$$zx = y$$

Note: if $x \notin \{\varepsilon, y\}$ then x is *proper suffix* of y .

Example: Consider 1010

Task: All suffixes of **1010**

Suffix of String

Gist: x is a suffix of zx

Definition: Let x and y be two strings over Σ ; x is *suffix* of y if there is a string z over Σ so

$$zx = y$$

Note: if $x \notin \{\varepsilon, y\}$ then x is *proper suffix* of y .

Example: Consider 1010

Task: All suffixes of **1010**

ε

Suffix of String

Gist: x is a suffix of zx

Definition: Let x and y be two strings over Σ ; x is *suffix* of y if there is a string z over Σ so

$$zx = y$$

Note: if $x \notin \{\varepsilon, y\}$ then x is *proper suffix* of y .

Example: Consider 1010

Task: All suffixes of **1010**

ε
0

Suffix of String

Gist: x is a suffix of zx

Definition: Let x and y be two strings over Σ ; x is *suffix* of y if there is a string z over Σ so

$$zx = y$$

Note: if $x \notin \{\varepsilon, y\}$ then x is *proper suffix* of y .

Example: Consider 1010

Task: All suffixes of **1010**

ε
0
10

Suffix of String

Gist: x is a suffix of zx

Definition: Let x and y be two strings over Σ ; x is *suffix* of y if there is a string z over Σ so

$$zx = y$$

Note: if $x \notin \{\varepsilon, y\}$ then x is *proper suffix* of y .

Example: Consider 1010

Task: All suffixes of **1010**

ε
 0
 10
 010

Suffix of String

Gist: x is a suffix of zx

Definition: Let x and y be two strings over Σ ; x is *suffix* of y if there is a string z over Σ so

$$zx = y$$

Note: if $x \notin \{\varepsilon, y\}$ then x is *proper suffix* of y .

Example: Consider 1010

Task: All suffixes of **1010**

ε
 0
 10
 010
 1010

Suffix of String

Gist: x is a suffix of zx

Definition: Let x and y be two strings over Σ ; x is *suffix* of y if there is a string z over Σ so

$$zx = y$$

Note: if $x \notin \{\varepsilon, y\}$ then x is *proper suffix* of y .

Example: Consider 1010

Task: All suffixes of **1010**

Suffixes of 1010 {
 ε
 0
 10
 010
 1010

Suffix of String

Gist: x is a suffix of zx

Definition: Let x and y be two strings over Σ ; x is *suffix* of y if there is a string z over Σ so

$$zx = y$$

Note: if $x \notin \{\varepsilon, y\}$ then x is *proper suffix* of y .

Example: Consider 1010

Task: All suffixes of **1010**

Suffixes of **1010** $\left\{ \begin{array}{l} \varepsilon \\ 0 \\ 10 \\ 010 \\ 1010 \end{array} \right\}$ Proper suffixes
of **1010**

Substring

Gist: x is a substring of zxz'

Definition: Let x and y be two strings over Σ ; x is *substring* of y if there are two string z, z' over Σ so $zxz' = y$.

Note: if $x \notin \{\varepsilon, y\}$ then x is *proper substring* of y .

Example: Consider 1010

Task: All substrings of **1 0 1 0**

Substring

Gist: x is a substring of zxz'

Definition: Let x and y be two strings over Σ ; x is *substring* of y if there are two string z, z' over Σ so $zxz' = y$.

Note: if $x \notin \{\varepsilon, y\}$ then x is *proper substring* of y .

Example: Consider 1010

Task: All substrings of **1 0 1 0**

ε

Substring

Gist: x is a substring of zxz'

Definition: Let x and y be two strings over Σ ; x is *substring* of y if there are two string z, z' over Σ so $zxz' = y$.

Note: if $x \notin \{\varepsilon, y\}$ then x is *proper substring* of y .

Example: Consider 1010

Task: All substrings of **1**0 1 0

ε

Substring

Gist: x is a substring of zxz'

Definition: Let x and y be two strings over Σ ; x is *substring* of y if there are two string z, z' over Σ so $zxz' = y$.

Note: if $x \notin \{\varepsilon, y\}$ then x is *proper substring* of y .

Example: Consider 1010

Task: All substrings of **1**0 1 0

ε
1

Substring

Gist: x is a substring of zxz'

Definition: Let x and y be two strings over Σ ; x is *substring* of y if there are two string z, z' over Σ so $zxz' = y$.

Note: if $x \notin \{\varepsilon, y\}$ then x is *proper substring* of y .

Example: Consider 1010

Task: All substrings of **1010**

ε

1

Substring

Gist: x is a substring of zxz'

Definition: Let x and y be two strings over Σ ; x is *substring* of y if there are two string z, z' over Σ so $zxz' = y$.

Note: if $x \notin \{\varepsilon, y\}$ then x is *proper substring* of y .

Example: Consider 1010

Task: All substrings of **1** **0** **1** **0**

ε
1

Substring

Gist: x is a substring of zxz'

Definition: Let x and y be two strings over Σ ; x is *substring* of y if there are two string z, z' over Σ so $zxz' = y$.

Note: if $x \notin \{\varepsilon, y\}$ then x is *proper substring* of y .

Example: Consider 1010

Task: All substrings of **1 0 1 0**

ε

1, 0

Substring

Gist: x is a substring of zxz'

Definition: Let x and y be two strings over Σ ; x is *substring* of y if there are two string z, z' over Σ so $zxz' = y$.

Note: if $x \notin \{\varepsilon, y\}$ then x is *proper substring* of y .

Example: Consider 1010

Task: All substrings of **1 0 1 0**

ε

1, 0

Substring

Gist: x is a substring of zxz'

Definition: Let x and y be two strings over Σ ; x is *substring* of y if there are two string z, z' over Σ so $zxz' = y$.

Note: if $x \notin \{\varepsilon, y\}$ then x is *proper substring* of y .

Example: Consider 1010

Task: All substrings of **1 0 1 0**

ε

1, 0

Substring

Gist: x is a substring of zxz'

Definition: Let x and y be two strings over Σ ; x is *substring* of y if there are two string z, z' over Σ so $zxz' = y$.

Note: if $x \notin \{\varepsilon, y\}$ then x is *proper substring* of y .

Example: Consider 1010

Task: All substrings of **1 0 1 0**

ε
 1, 0

Substring

Gist: x is a substring of zxz'

Definition: Let x and y be two strings over Σ ; x is *substring* of y if there are two string z, z' over Σ so $zxz' = y$.

Note: if $x \notin \{\varepsilon, y\}$ then x is *proper substring* of y .

Example: Consider 1010

Task: All substrings of **1 0** 1 0

ε
1, 0

Substring

Gist: x is a substring of zxz'

Definition: Let x and y be two strings over Σ ; x is *substring* of y if there are two string z, z' over Σ so $zxz' = y$.

Note: if $x \notin \{\varepsilon, y\}$ then x is *proper substring* of y .

Example: Consider 1010

Task: All substrings of **1 0 1 0**

ε

1, 0

Substring

Gist: x is a substring of zxz'

Definition: Let x and y be two strings over Σ ; x is *substring* of y if there are two string z, z' over Σ so $zxz' = y$.

Note: if $x \notin \{\varepsilon, y\}$ then x is *proper substring* of y .

Example: Consider 1010

Task: All substrings of **1 0 1 0**

ε

1, 0

Substring

Gist: x is a substring of zxz'

Definition: Let x and y be two strings over Σ ; x is *substring* of y if there are two string z, z' over Σ so $zxz' = y$.

Note: if $x \notin \{\varepsilon, y\}$ then x is *proper substring* of y .

Example: Consider 1010

Task: All substrings of **1 0 1 0**

ε
1, 0

Substring

Gist: x is a substring of zxz'

Definition: Let x and y be two strings over Σ ; x is *substring* of y if there are two string z, z' over Σ so $zxz' = y$.

Note: if $x \notin \{\varepsilon, y\}$ then x is *proper substring* of y .

Example: Consider 1010

Task: All substrings of **1 0 1 0**

ε
1, 0

Substring

Gist: x is a substring of zxz'

Definition: Let x and y be two strings over Σ ; x is *substring* of y if there are two string z, z' over Σ so $zxz' = y$.

Note: if $x \notin \{\varepsilon, y\}$ then x is *proper substring* of y .

Example: Consider 1010

Task: All substrings of **1 0 1 0**

ε

1, 0

Substring

Gist: x is a substring of zxz'

Definition: Let x and y be two strings over Σ ; x is *substring* of y if there are two string z, z' over Σ so $zxz' = y$.

Note: if $x \notin \{\varepsilon, y\}$ then x is *proper substring* of y .

Example: Consider 1010

Task: All substrings of **1 0** 1 0

ε

1, 0

Substring

Gist: x is a substring of zxz'

Definition: Let x and y be two strings over Σ ; x is *substring* of y if there are two string z, z' over Σ so $zxz' = y$.

Note: if $x \notin \{\varepsilon, y\}$ then x is *proper substring* of y .

Example: Consider 1010

Task: All substrings of **1 0** 1 0

ε

1, 0

10

Substring

Gist: x is a substring of zxz'

Definition: Let x and y be two strings over Σ ; x is *substring* of y if there are two string z, z' over Σ so $zxz' = y$.

Note: if $x \notin \{\varepsilon, y\}$ then x is *proper substring* of y .

Example: Consider 1010

Task: All substrings of **1 0 1 0**

ε

1, 0

10

Substring

Gist: x is a substring of zxz'

Definition: Let x and y be two strings over Σ ; x is *substring* of y if there are two string z, z' over Σ so $zxz' = y$.

Note: if $x \notin \{\varepsilon, y\}$ then x is *proper substring* of y .

Example: Consider 1010

Task: All substrings of **1 0 1 0**

ε

1, 0

10

Substring

Gist: x is a substring of zxz'

Definition: Let x and y be two strings over Σ ; x is *substring* of y if there are two string z, z' over Σ so $zxz' = y$.

Note: if $x \notin \{\varepsilon, y\}$ then x is *proper substring* of y .

Example: Consider 1010

Task: All substrings of **1 0 1 0**

ε

1, 0

10, 01

Substring

Gist: x is a substring of zxz'

Definition: Let x and y be two strings over Σ ; x is *substring* of y if there are two string z, z' over Σ so $zxz' = y$.

Note: if $x \notin \{\varepsilon, y\}$ then x is *proper substring* of y .

Example: Consider 1010

Task: All substrings of **1 0 1 0**

ε

1, 0

10, 01

Substring

Gist: x is a substring of zxz'

Definition: Let x and y be two strings over Σ ; x is *substring* of y if there are two string z, z' over Σ so $zxz' = y$.

Note: if $x \notin \{\varepsilon, y\}$ then x is *proper substring* of y .

Example: Consider 1010

Task: All substrings of **1 0 1 0**

ε

1, 0

10, 01

Substring

Gist: x is a substring of zxz'

Definition: Let x and y be two strings over Σ ; x is *substring* of y if there are two string z, z' over Σ so $zxz' = y$.

Note: if $x \notin \{\varepsilon, y\}$ then x is *proper substring* of y .

Example: Consider 1010

Task: All substrings of **1 0 1 0**

ε
 1, 0
 10, 01

Substring

Gist: x is a substring of zxz'

Definition: Let x and y be two strings over Σ ; x is *substring* of y if there are two string z, z' over Σ so $zxz' = y$.

Note: if $x \notin \{\varepsilon, y\}$ then x is *proper substring* of y .

Example: Consider 1010

Task: All substrings of **1 0 1 0**

ε
 1, 0
 10, 01

Substring

Gist: x is a substring of zxz'

Definition: Let x and y be two strings over Σ ; x is *substring* of y if there are two string z, z' over Σ so $zxz' = y$.

Note: if $x \notin \{\varepsilon, y\}$ then x is *proper substring* of y .

Example: Consider 1010

Task: All substrings of **1 0 1 0**

ε

1, 0

10, 01

Substring

Gist: x is a substring of zxz'

Definition: Let x and y be two strings over Σ ; x is *substring* of y if there are two string z, z' over Σ so $zxz' = y$.

Note: if $x \notin \{\varepsilon, y\}$ then x is *proper substring* of y .

Example: Consider 1010

Task: All substrings of **1 0 1 0**

ε

1, 0

10, 01

Substring

Gist: x is a substring of zxz'

Definition: Let x and y be two strings over Σ ; x is *substring* of y if there are two string z, z' over Σ so $zxz' = y$.

Note: if $x \notin \{\varepsilon, y\}$ then x is *proper substring* of y .

Example: Consider 1010

Task: All substrings of **1 0 1 0**

ε

1, 0

10, 01

101

Substring

Gist: x is a substring of zxz'

Definition: Let x and y be two strings over Σ ; x is *substring* of y if there are two string z, z' over Σ so $zxz' = y$.

Note: if $x \notin \{\varepsilon, y\}$ then x is *proper substring* of y .

Example: Consider 1010

Task: All substrings of **1 0 1 0**

ε

1, 0

10, 01

101

Substring

Gist: x is a substring of zxz'

Definition: Let x and y be two strings over Σ ; x is *substring* of y if there are two string z, z' over Σ so $zxz' = y$.

Note: if $x \notin \{\varepsilon, y\}$ then x is *proper substring* of y .

Example: Consider 1010

Task: All substrings of **1 0 1 0**

ε

1, 0

10, 01

101

Substring

Gist: x is a substring of zxz'

Definition: Let x and y be two strings over Σ ; x is *substring* of y if there are two string z, z' over Σ so $zxz' = y$.

Note: if $x \notin \{\varepsilon, y\}$ then x is *proper substring* of y .

Example: Consider 1010

Task: All substrings of **1 0 1 0**

ε

1, 0

10, 01

101, 010

Substring

Gist: x is a substring of zxz'

Definition: Let x and y be two strings over Σ ; x is *substring* of y if there are two string z, z' over Σ so $zxz' = y$.

Note: if $x \notin \{\varepsilon, y\}$ then x is *proper substring* of y .

Example: Consider 1010

Task: All substrings of **1 0 1 0**

ε

1, 0

10, 01

101, 010

Substring

Gist: x is a substring of zxz'

Definition: Let x and y be two strings over Σ ; x is *substring* of y if there are two string z, z' over Σ so $zxz' = y$.

Note: if $x \notin \{\varepsilon, y\}$ then x is *proper substring* of y .

Example: Consider 1010

Task: All substrings of **1 0 1 0**

ε

1, 0

10, 01

101, 010

Substring

Gist: x is a substring of zxz'

Definition: Let x and y be two strings over Σ ; x is *substring* of y if there are two string z, z' over Σ so $zxz' = y$.

Note: if $x \notin \{\varepsilon, y\}$ then x is *proper substring* of y .

Example: Consider 1010

Task: All substrings of **1 0 1 0**

ε

1, 0

10, 01

101, 010

1010

Substring

Gist: x is a substring of zxz'

Definition: Let x and y be two strings over Σ ; x is *substring* of y if there are two string z, z' over Σ so $zxz' = y$.

Note: if $x \notin \{\varepsilon, y\}$ then x is *proper substring* of y .

Example: Consider 1010

Task: All substrings of **1 0 1 0**

ε

1, 0

10, 01

101, 010

1010

Substring

Gist: x is a substring of zxz'

Definition: Let x and y be two strings over Σ ; x is *substring* of y if there are two string z, z' over Σ so $zxz' = y$.

Note: if $x \notin \{\varepsilon, y\}$ then x is *proper substring* of y .

Example: Consider 1010

Task: All substrings of **1 0 1 0**

Substrings
of 1010

ε
1, 0
10, 01
101, 010
1010

Substring

Gist: x is a substring of zxz'

Definition: Let x and y be two strings over Σ ; x is *substring* of y if there are two string z, z' over Σ so $zxz' = y$.

Note: if $x \notin \{\varepsilon, y\}$ then x is *proper substring* of y .

Example: Consider 1010

Task: All substrings of **1 0 1 0**

Substrings
of 1010

ε
 1, 0
 10, 01
 101, 010
 1010

Substring

Gist: x is a substring of zxz'

Definition: Let x and y be two strings over Σ ; x is *substring* of y if there are two string z, z' over Σ so $zxz' = y$.

Note: if $x \notin \{\varepsilon, y\}$ then x is *proper substring* of y .

Example: Consider 1010

Task: All substrings of **1 0 1 0**

Substrings
of 1010

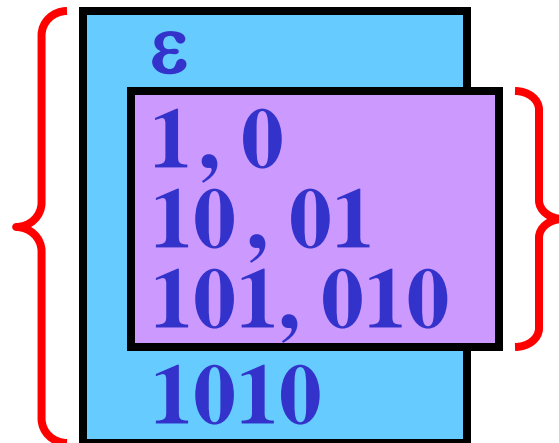

Proper substrings
of 1010

Languages

Gist: $L \subseteq \Sigma^*$

Definition: Let Σ^* denote the set of all strings over Σ . Every subset $L \subseteq \Sigma^*$ is a *language* over Σ .

Note: Σ^+ denote the set $\Sigma^* - \{\epsilon\}$.

Example: Consider $\Sigma = \{0, 1\}$:

Languages

Gist: $L \subseteq \Sigma^*$

Definition: Let Σ^* denote the set of all strings over Σ . Every subset $L \subseteq \Sigma^*$ is a *language* over Σ .

Note: Σ^+ denote the set $\Sigma^* - \{\epsilon\}$.

Example: Consider $\Sigma = \{0, 1\}$:

Set Σ^*



Languages

Gist: $L \subseteq \Sigma^*$

Definition: Let Σ^* denote the set of all strings over Σ . Every subset $L \subseteq \Sigma^*$ is a *language* over Σ .

Note: Σ^+ denote the set $\Sigma^* - \{\varepsilon\}$.

Example: Consider $\Sigma = \{0, 1\}$:

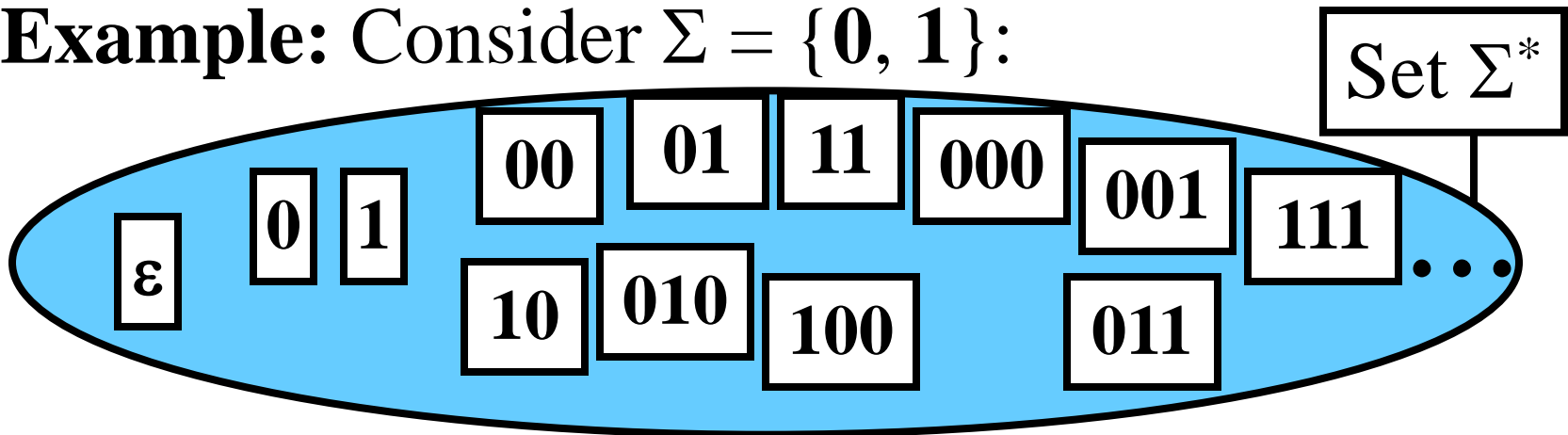

Languages

Gist: $L \subseteq \Sigma^*$

Definition: Let Σ^* denote the set of all strings over Σ . Every subset $L \subseteq \Sigma^*$ is a *language* over Σ .

Note: Σ^+ denote the set $\Sigma^* - \{\epsilon\}$.

Example: Consider $\Sigma = \{0, 1\}$:

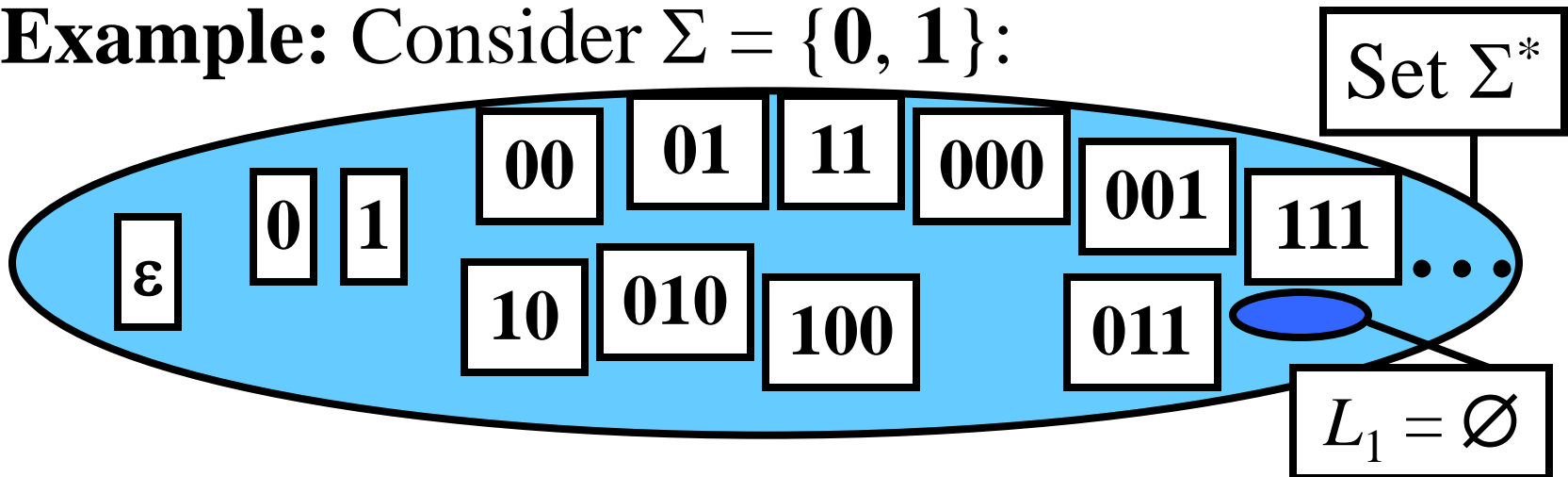

Languages

Gist: $L \subseteq \Sigma^*$

Definition: Let Σ^* denote the set of all strings over Σ . Every subset $L \subseteq \Sigma^*$ is a *language* over Σ .

Note: Σ^+ denote the set $\Sigma^* - \{\varepsilon\}$.

Example: Consider $\Sigma = \{0, 1\}$:

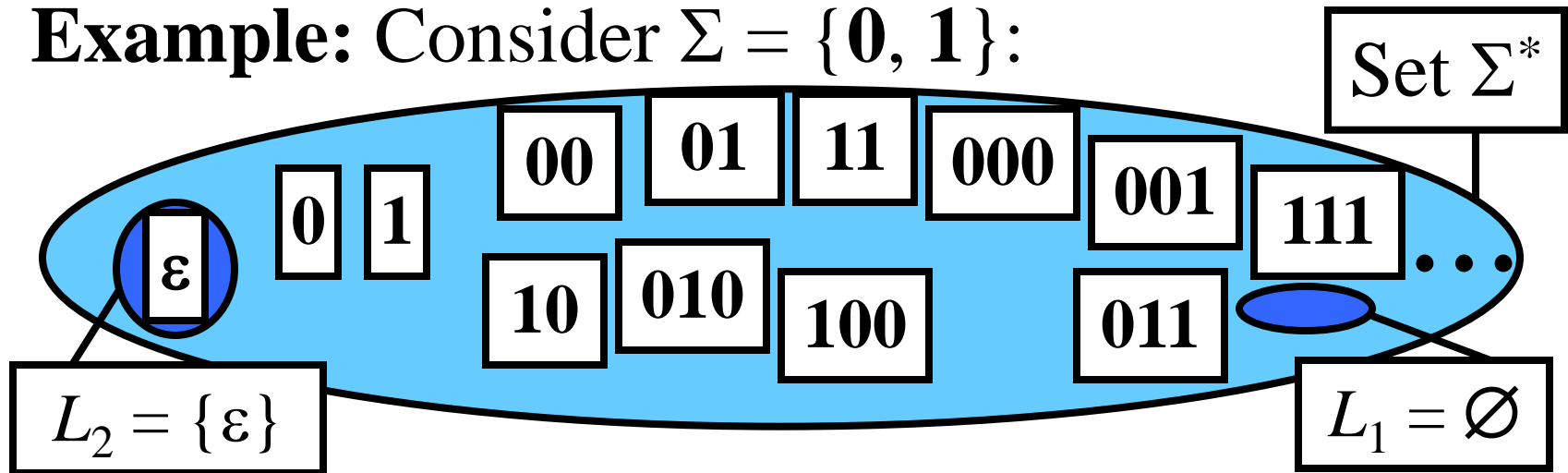

Languages

Gist: $L \subseteq \Sigma^*$

Definition: Let Σ^* denote the set of all strings over Σ . Every subset $L \subseteq \Sigma^*$ is a *language* over Σ .

Note: Σ^+ denote the set $\Sigma^* - \{\varepsilon\}$.

Example: Consider $\Sigma = \{0, 1\}$:

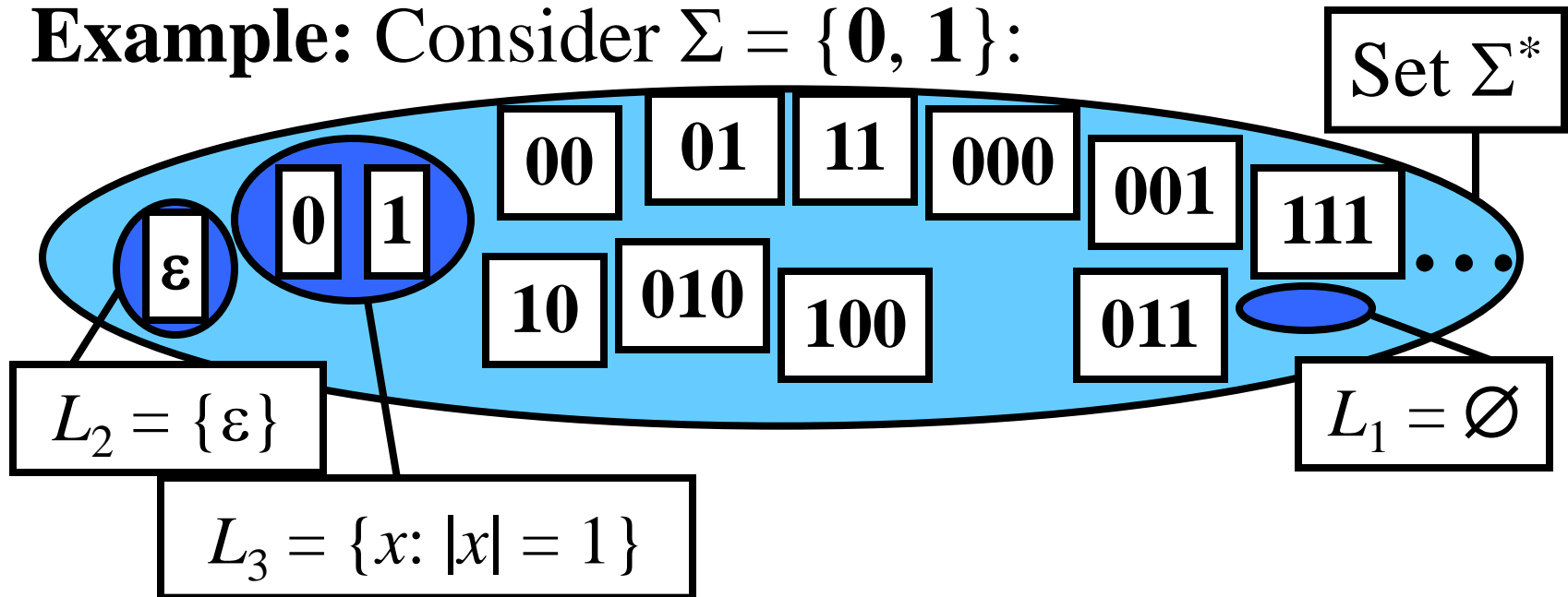

Languages

Gist: $L \subseteq \Sigma^*$

Definition: Let Σ^* denote the set of all strings over Σ . Every subset $L \subseteq \Sigma^*$ is a *language* over Σ .

Note: Σ^+ denote the set $\Sigma^* - \{\epsilon\}$.

Example: Consider $\Sigma = \{0, 1\}$:

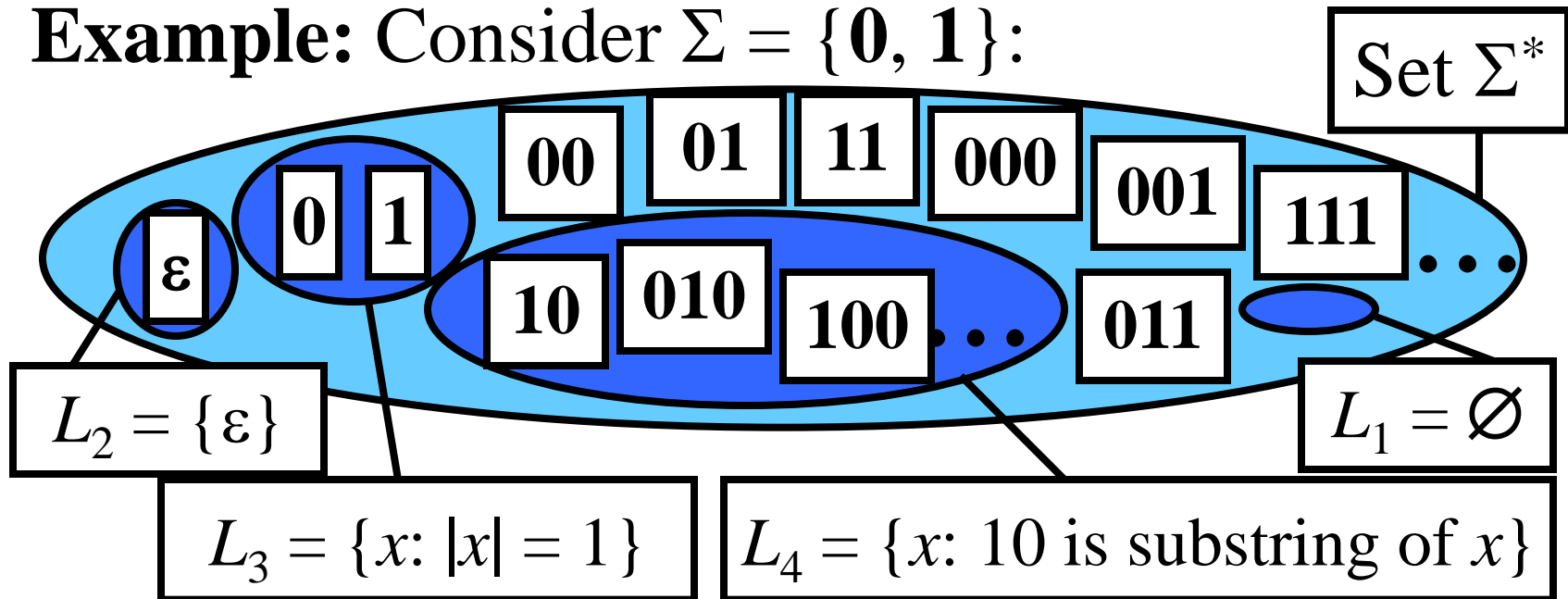

Languages

Gist: $L \subseteq \Sigma^*$

Definition: Let Σ^* denote the set of all strings over Σ . Every subset $L \subseteq \Sigma^*$ is a *language* over Σ .

Note: Σ^+ denote the set $\Sigma^* - \{\epsilon\}$.

Example: Consider $\Sigma = \{0, 1\}$:

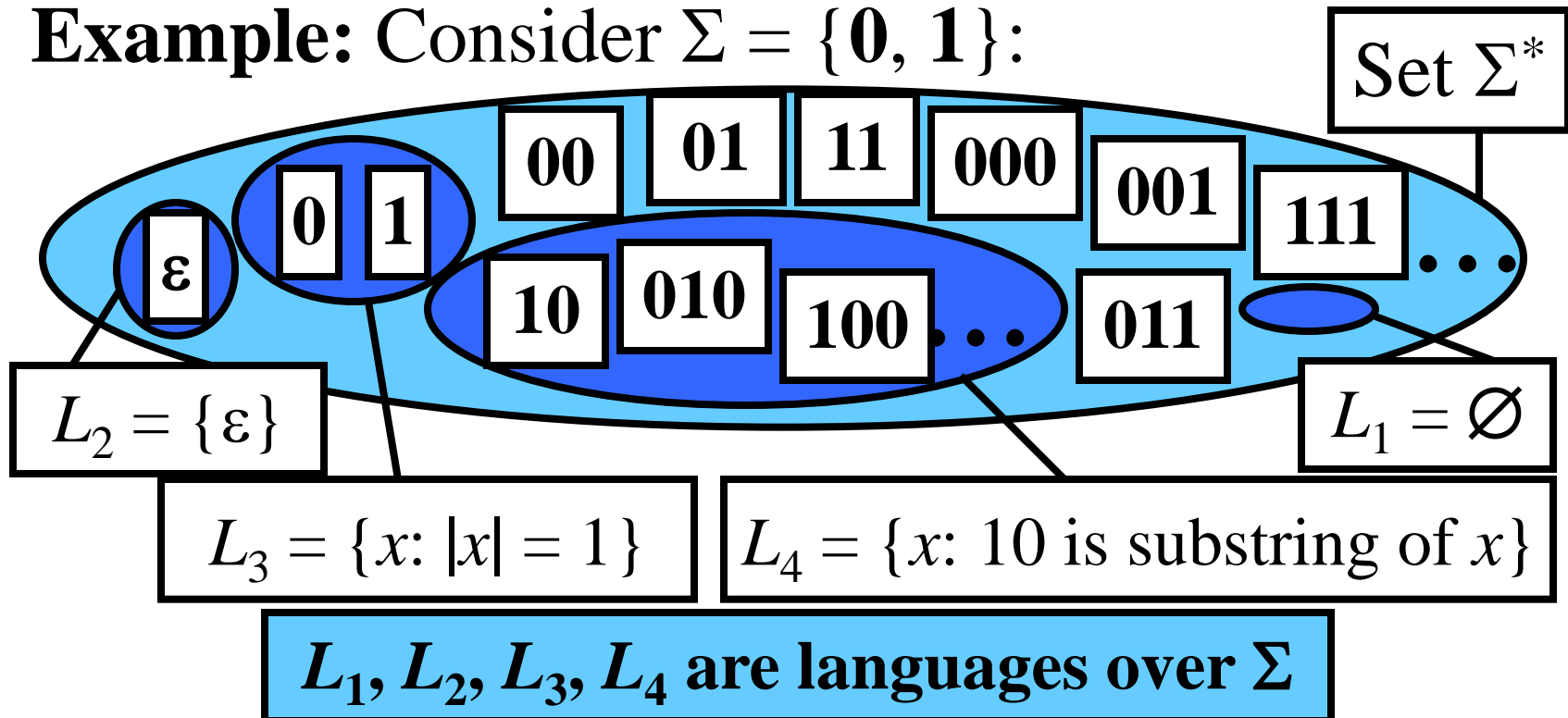

Finite and Infinite Languages

Gist: finite language contains a finite number of strings

Definition: A language, L , is *finite* if L contains a finite number of strings; otherwise, L is *infinite*.

Note: Let S be a set; $\text{card}(S)$ is the number of its members.

Finite and Infinite Languages

Gist: finite language contains a finite number of strings

Definition: A language, L , is *finite* if L contains a finite number of strings; otherwise, L is *infinite*.

Note: Let S be a set; $\text{card}(S)$ is the number of its members.

Examples:

- $L_1 = \emptyset$ is **finite** because $\text{card}(L_1) = \mathbf{0}$
- $L_2 = \{\varepsilon\}$ is **finite** because $\text{card}(L_2) = \mathbf{1}$
- $L_3 = \{x: |x| = 1\} = \{0, 1\}$ is **finite** because
 $\text{card}(L_3) = \mathbf{2}$
- $L_4 = \{x: 10 \text{ is substring of } x\} = \{10, 010, 100, \dots\}$
 is **infinite**

Union of Languages

Gist: Union of L_1 and L_2 is $L_1 \cup L_2$

Definition: Let L_1 and L_2 be two languages over Σ .

The *union* of L_1 and L_2 , $L_1 \cup L_2$, is defined as

$$L_1 \cup L_2 = \{x: x \in L_1 \text{ or } x \in L_2\}$$

Example: Consider languages $L_1 = \{0, 1, 00, 01\}$,

$L_2 = \{00, 01, 10, 11\}$

Task: $L_1 \cup L_2$

Union of Languages

Gist: Union of L_1 and L_2 is $L_1 \cup L_2$

Definition: Let L_1 and L_2 be two languages over Σ . The *union* of L_1 and L_2 , $L_1 \cup L_2$, is defined as

$$L_1 \cup L_2 = \{x: x \in L_1 \text{ or } x \in L_2\}$$

Example: Consider languages $L_1 = \{0, 1, 00, 01\}$,
 $L_2 = \{00, 01, 10, 11\}$

Task: $L_1 \cup L_2$

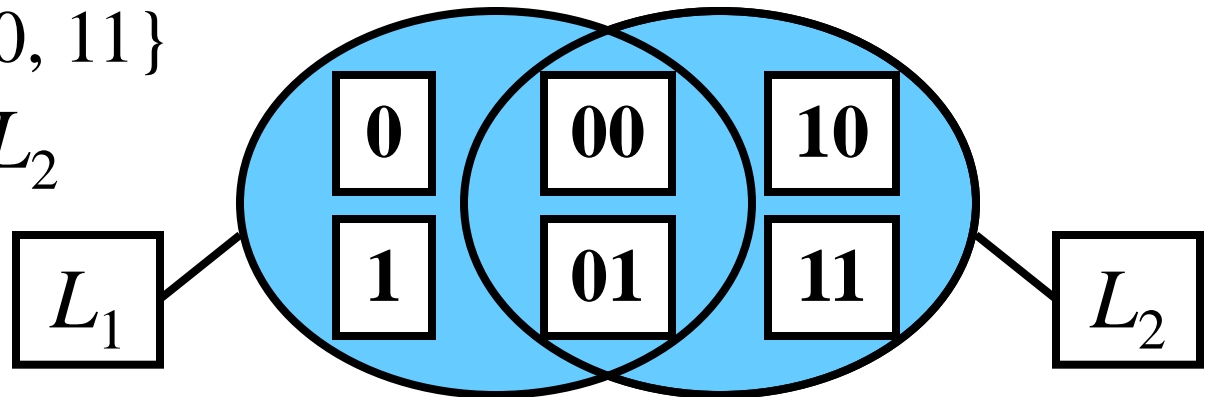

Union of Languages

Gist: Union of L_1 and L_2 is $L_1 \cup L_2$

Definition: Let L_1 and L_2 be two languages over Σ . The *union* of L_1 and L_2 , $L_1 \cup L_2$, is defined as

$$L_1 \cup L_2 = \{x: x \in L_1 \text{ or } x \in L_2\}$$

Example: Consider languages $L_1 = \{0, 1, 00, 01\}$,
 $L_2 = \{00, 01, 10, 11\}$

Task: $L_1 \cup L_2$

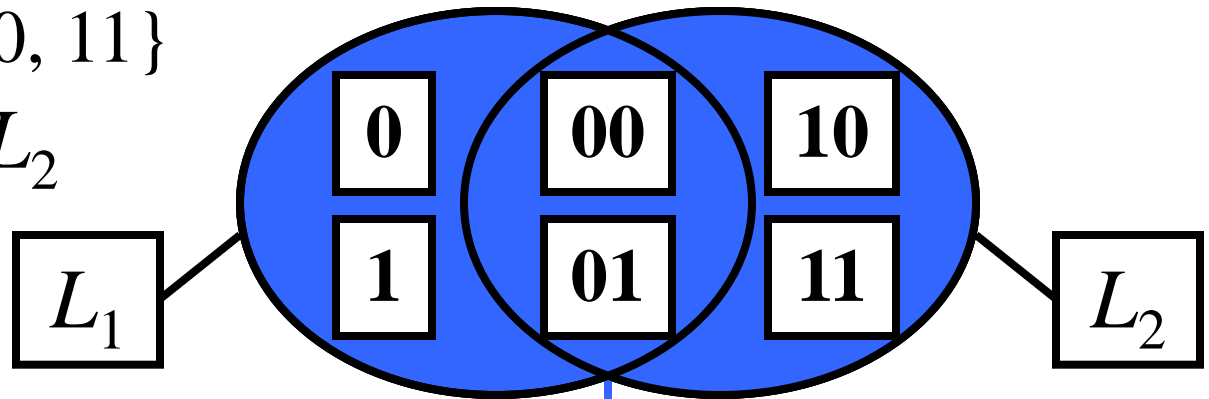

$$L_1 \cup L_2 = \{0, 1, 00, 01, 10, 11\}$$

Intersection of Languages

Gist: Intersection of L_1 and L_2 is $L_1 \cap L_2$

Definition: Let L_1 and L_2 be two languages over Σ . The *intersection* of L_1 and L_2 , $L_1 \cap L_2$, is defined as:

$$L_1 \cap L_2 = \{x: x \in L_1 \text{ and } x \in L_2\}$$

Example: Consider languages $L_1 = \{0, 1, 00, 01\}$,
 $L_2 = \{00, 01, 10, 11\}$.

Task: $L_1 \cap L_2$

Intersection of Languages

Gist: Intersection of L_1 and L_2 is $L_1 \cap L_2$

Definition: Let L_1 and L_2 be two languages over Σ . The *intersection* of L_1 and L_2 , $L_1 \cap L_2$, is defined as:

$$L_1 \cap L_2 = \{x: x \in L_1 \text{ and } x \in L_2\}$$

Example: Consider languages $L_1 = \{0, 1, 00, 01\}$,
 $L_2 = \{00, 01, 10, 11\}$.

Task: $L_1 \cap L_2$

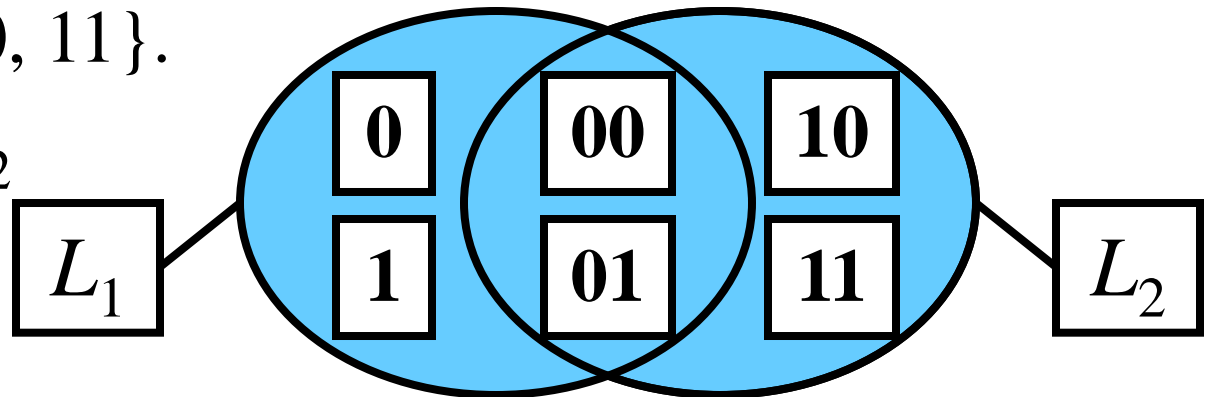

Intersection of Languages

Gist: Intersection of L_1 and L_2 is $L_1 \cap L_2$

Definition: Let L_1 and L_2 be two languages over Σ . The *intersection* of L_1 and L_2 , $L_1 \cap L_2$, is defined as:

$$L_1 \cap L_2 = \{x: x \in L_1 \text{ and } x \in L_2\}$$

Example: Consider languages $L_1 = \{0, 1, 00, 01\}$,
 $L_2 = \{00, 01, 10, 11\}$.

Task: $L_1 \cap L_2$

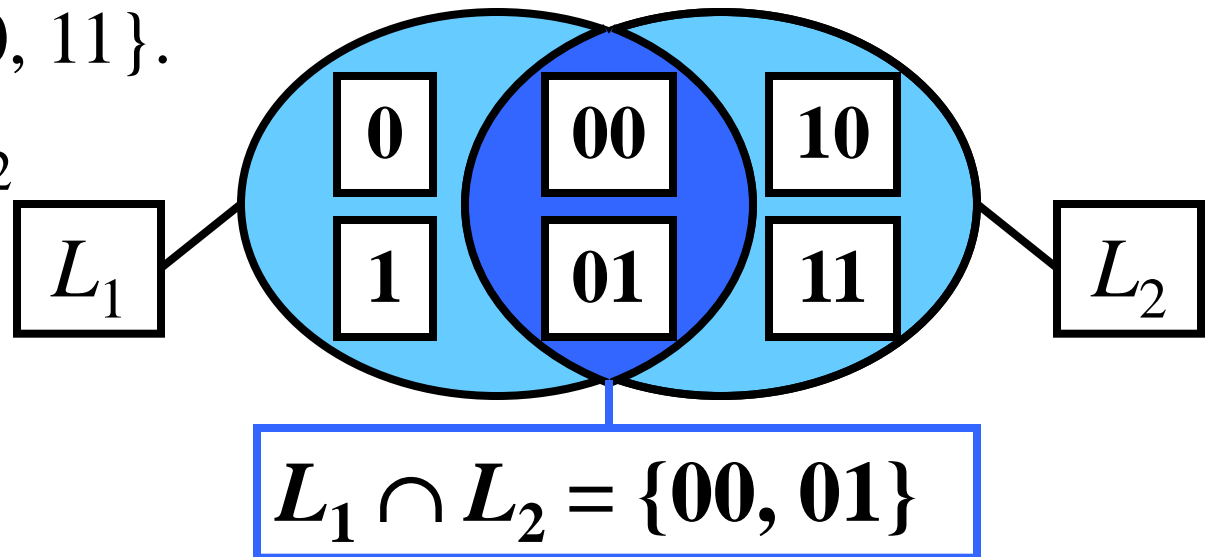

Difference of Languages

Gist: Difference of L_1 and L_2 is $L_1 - L_2$

Definition: Let L_1 and L_2 be two languages over Σ . The *difference* of L_1 and L_2 , $L_1 - L_2$, is defined as

$$L_1 - L_2 = \{x: x \in L_1 \text{ and } x \notin L_2\}$$

Example: Consider languages $L_1 = \{0, 1, 00, 01\}$,
 $L_2 = \{00, 01, 10, 11\}$

Task: $L_1 - L_2$

Difference of Languages

Gist: Difference of L_1 and L_2 is $L_1 - L_2$

Definition: Let L_1 and L_2 be two languages over Σ . The *difference* of L_1 and L_2 , $L_1 - L_2$, is defined as

$$L_1 - L_2 = \{x: x \in L_1 \text{ and } x \notin L_2\}$$

Example: Consider languages $L_1 = \{0, 1, 00, 01\}$,
 $L_2 = \{00, 01, 10, 11\}$

Task: $L_1 - L_2$

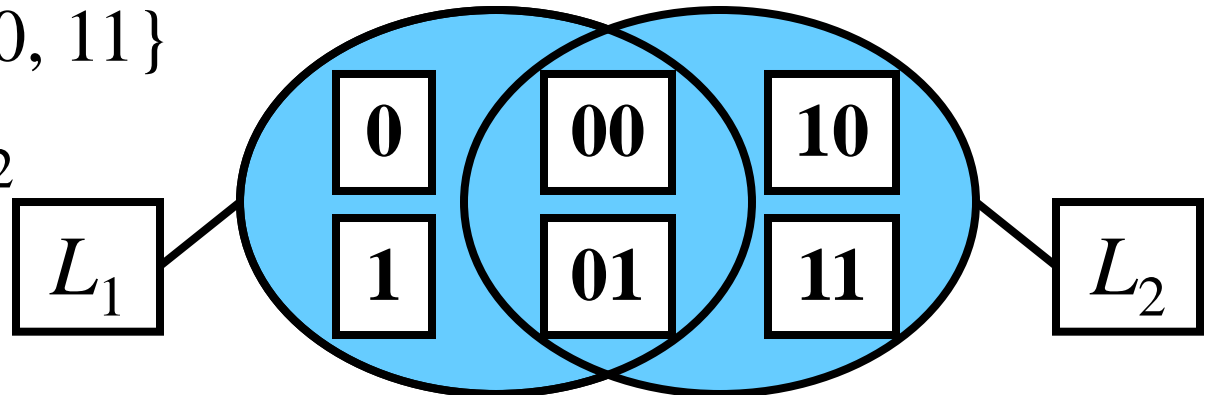

Difference of Languages

Gist: Difference of L_1 and L_2 is $L_1 - L_2$

Definition: Let L_1 and L_2 be two languages over Σ . The *difference* of L_1 and L_2 , $L_1 - L_2$, is defined as

$$L_1 - L_2 = \{x: x \in L_1 \text{ and } x \notin L_2\}$$

Example: Consider languages $L_1 = \{0, 1, 00, 01\}$,
 $L_2 = \{00, 01, 10, 11\}$

Task: $L_1 - L_2$

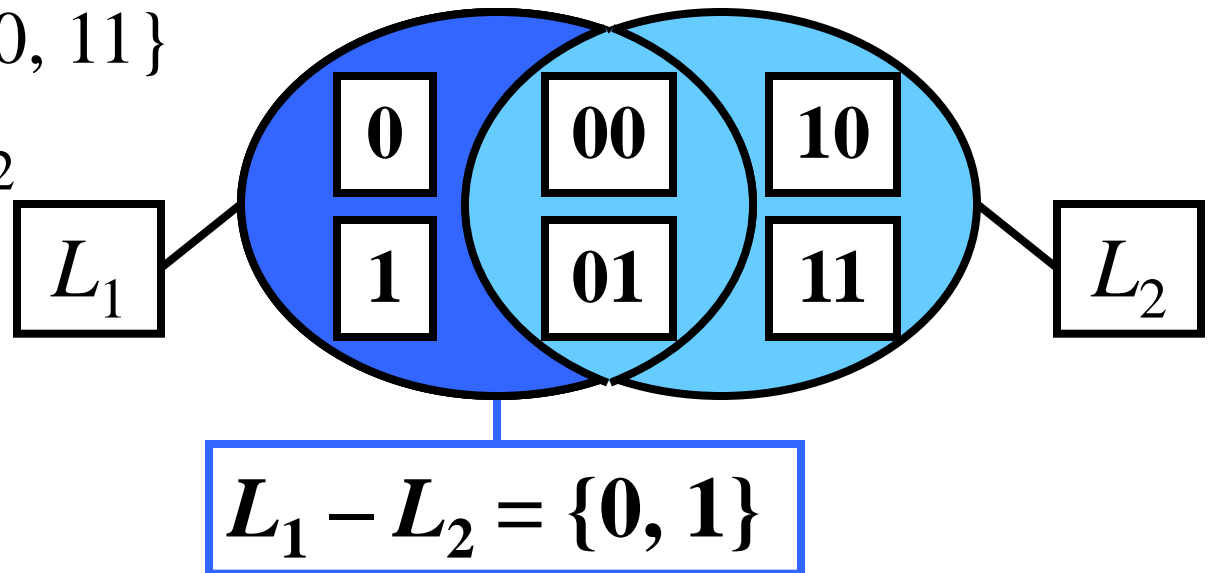

Complement of Language

Gist: $\bar{L} = \Sigma^* - L$

Definition: Let L be a language over Σ .

The *complement* of L , \bar{L} , is defined as

$$\bar{L} = \Sigma^* - L$$

Example: Consider language $L = \{0, 1, 01, 10\}$

Task: \bar{L}

Complement of Language

Gist: $\bar{L} = \Sigma^* - L$

Definition: Let L be a languages over Σ .
The *complement* of L , \bar{L} , is defined as

$$\bar{L} = \Sigma^* - L$$

Example: Consider language $L = \{0, 1, 01, 10\}$

Task: \bar{L}

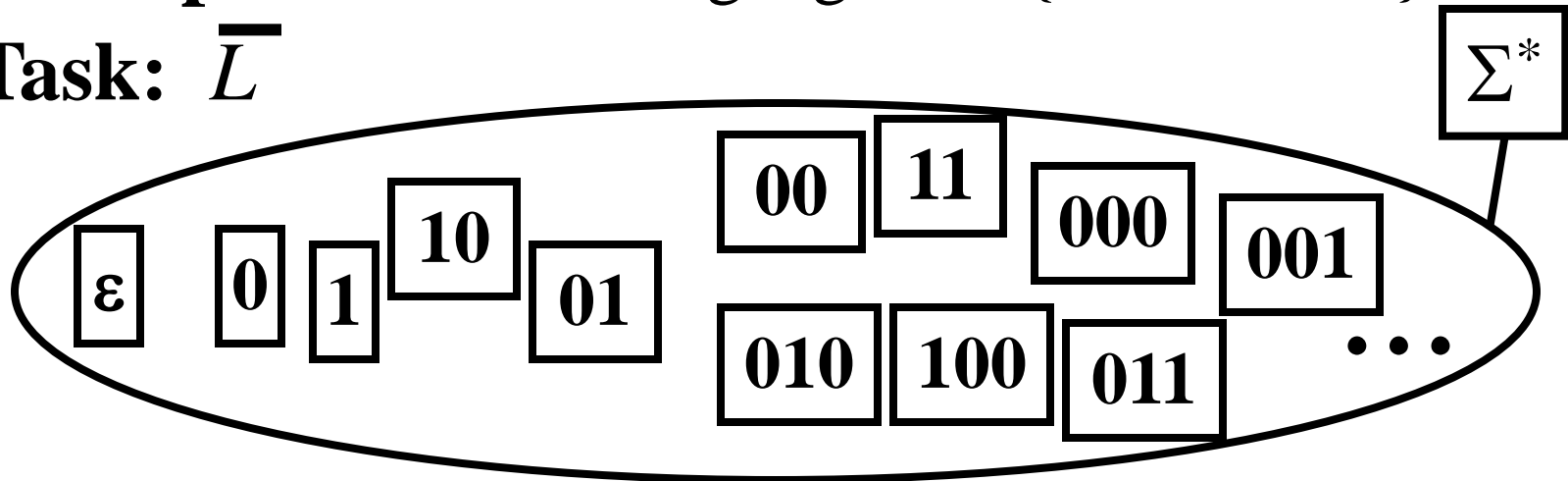

Complement of Language

Gist: $\bar{L} = \Sigma^* - L$

Definition: Let L be a languages over Σ .
The *complement* of L , \bar{L} , is defined as

$$\bar{L} = \Sigma^* - L$$

Example: Consider language $L = \{0, 1, 01, 10\}$

Task: \bar{L}

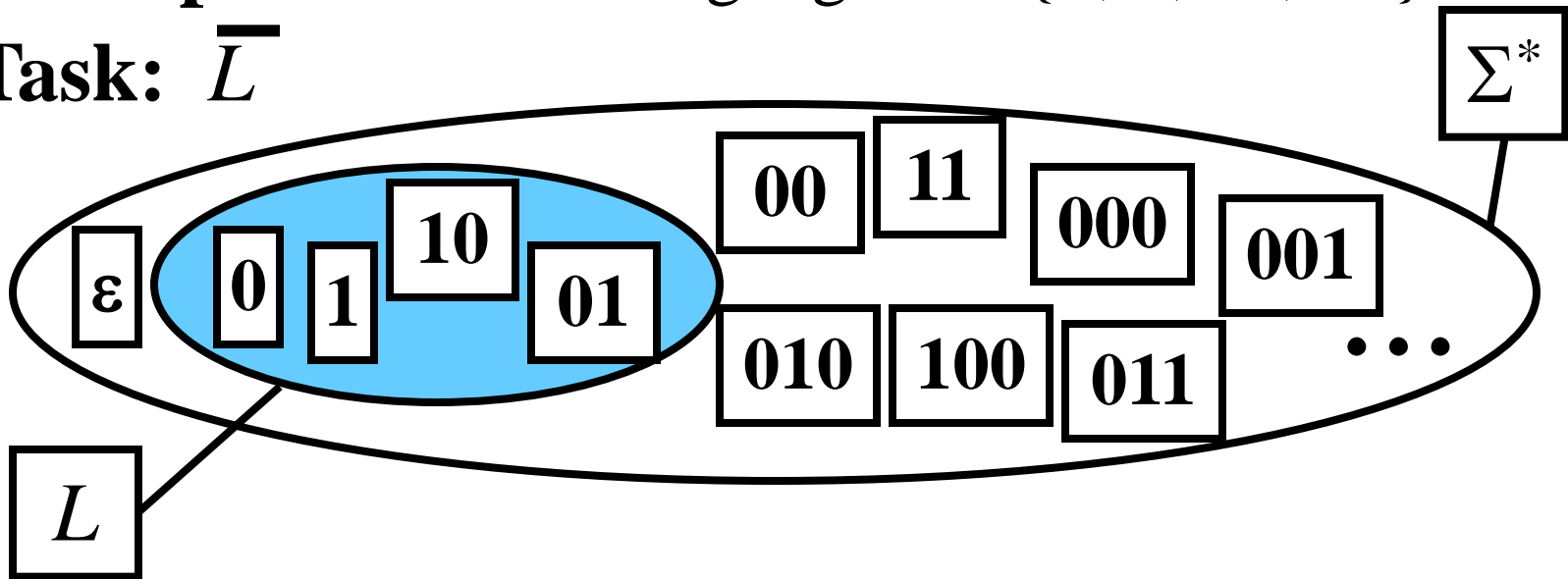

Complement of Language

Gist: $\bar{L} = \Sigma^* - L$

Definition: Let L be a languages over Σ .
The *complement* of L , \bar{L} , is defined as

$$\bar{L} = \Sigma^* - L$$

Example: Consider language $L = \{0, 1, 01, 10\}$

Task: \bar{L}

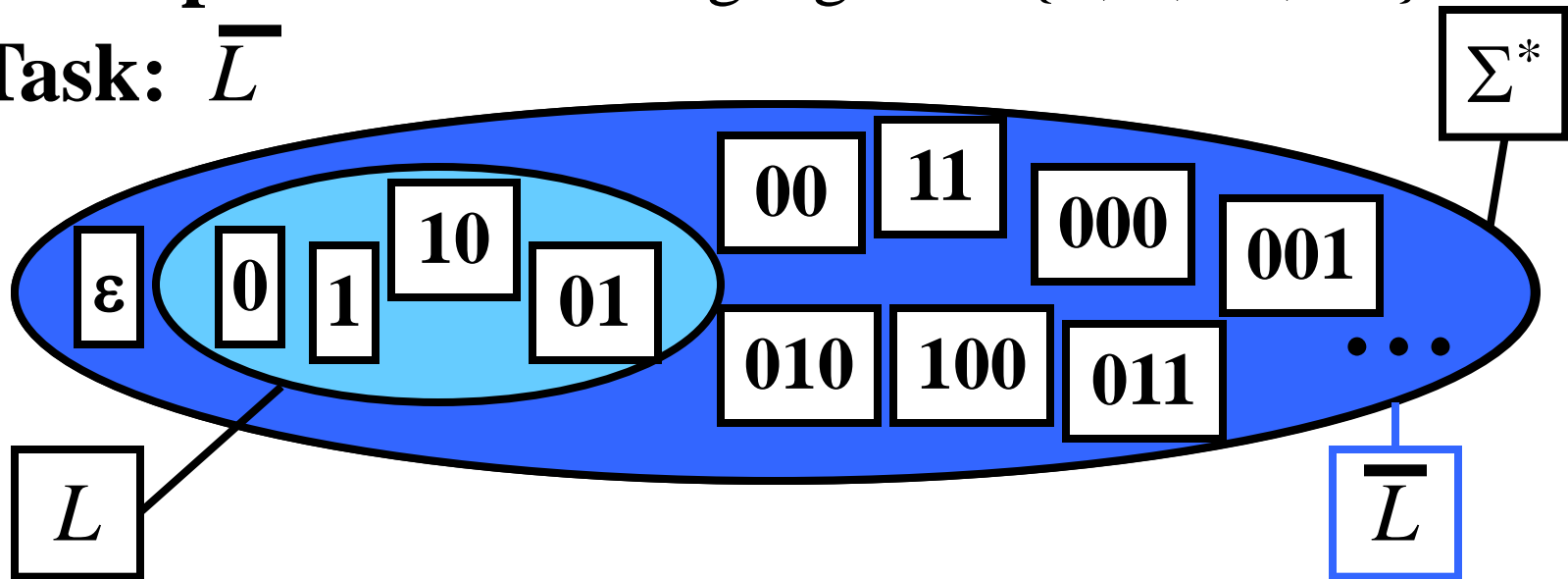

Concatenation of Languages

Gist: $L_1L_2 = \{xy: x \in L_1 \text{ and } y \in L_2\}$

Definition: Let L_1 and L_2 be two languages over Σ . The *concatenation* of L_1 and L_2 , L_1L_2 , is defined as

$$L_1L_2 = \{xy: x \in L_1 \text{ and } y \in L_2\}$$

Note: 1) $L\{\varepsilon\} = \{\varepsilon\}L = L$ 2) $L\emptyset = \emptyset L = \emptyset$

Example: Consider languages $L_1 = \{0, 1\}$, $L_2 = \{00, 01\}$

Task: L_1L_2

Concatenation of Languages

Gist: $L_1L_2 = \{xy: x \in L_1 \text{ and } y \in L_2\}$

Definition: Let L_1 and L_2 be two languages over Σ . The *concatenation* of L_1 and L_2 , L_1L_2 , is defined as

$$L_1L_2 = \{xy: x \in L_1 \text{ and } y \in L_2\}$$

Note: 1) $L\{\varepsilon\} = \{\varepsilon\}L = L$ 2) $L\emptyset = \emptyset L = \emptyset$

Example: Consider languages $L_1 = \{0, 1\}$, $L_2 = \{00, 01\}$

Task: L_1L_2

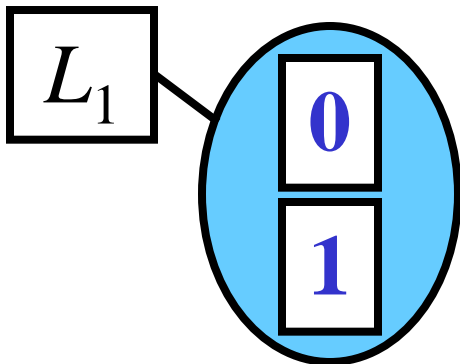

Concatenation of Languages

Gist: $L_1L_2 = \{xy: x \in L_1 \text{ and } y \in L_2\}$

Definition: Let L_1 and L_2 be two languages over Σ . The *concatenation* of L_1 and L_2 , L_1L_2 , is defined as

$$L_1L_2 = \{xy: x \in L_1 \text{ and } y \in L_2\}$$

Note: 1) $L\{\varepsilon\} = \{\varepsilon\}L = L$ 2) $L\emptyset = \emptyset L = \emptyset$

Example: Consider languages $L_1 = \{0, 1\}$, $L_2 = \{00, 01\}$

Task: L_1L_2



Concatenation of Languages

Gist: $L_1L_2 = \{xy: x \in L_1 \text{ and } y \in L_2\}$

Definition: Let L_1 and L_2 be two languages over Σ . The *concatenation* of L_1 and L_2 , L_1L_2 , is defined as

$$L_1L_2 = \{xy: x \in L_1 \text{ and } y \in L_2\}$$

Note: 1) $L\{\varepsilon\} = \{\varepsilon\}L = L$ 2) $L\emptyset = \emptyset L = \emptyset$

Example: Consider languages $L_1 = \{0, 1\}$, $L_2 = \{00, 01\}$

Task: L_1L_2



Concatenation of Languages

Gist: $L_1L_2 = \{xy: x \in L_1 \text{ and } y \in L_2\}$

Definition: Let L_1 and L_2 be two languages over Σ . The *concatenation* of L_1 and L_2 , L_1L_2 , is defined as

$$L_1L_2 = \{xy: x \in L_1 \text{ and } y \in L_2\}$$

Note: 1) $L\{\varepsilon\} = \{\varepsilon\}L = L$ 2) $L\emptyset = \emptyset L = \emptyset$

Example: Consider languages $L_1 = \{0, 1\}$, $L_2 = \{00, 01\}$

Task: L_1L_2

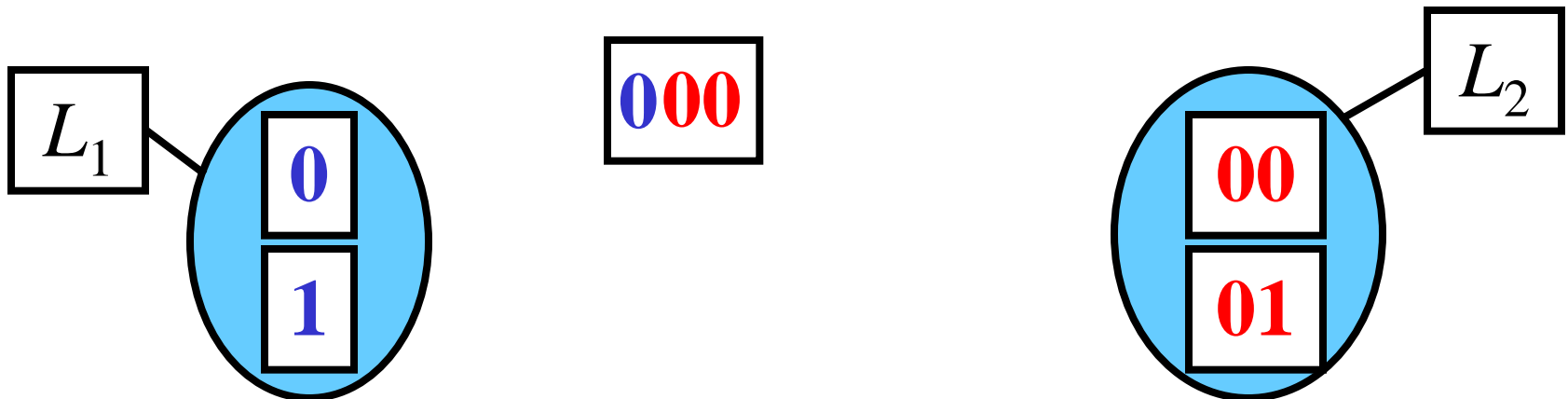

Concatenation of Languages

Gist: $L_1L_2 = \{xy: x \in L_1 \text{ and } y \in L_2\}$

Definition: Let L_1 and L_2 be two languages over Σ . The *concatenation* of L_1 and L_2 , L_1L_2 , is defined as

$$L_1L_2 = \{xy: x \in L_1 \text{ and } y \in L_2\}$$

Note: 1) $L\{\varepsilon\} = \{\varepsilon\}L = L$ 2) $L\emptyset = \emptyset L = \emptyset$

Example: Consider languages $L_1 = \{0, 1\}$, $L_2 = \{00, 01\}$

Task: L_1L_2

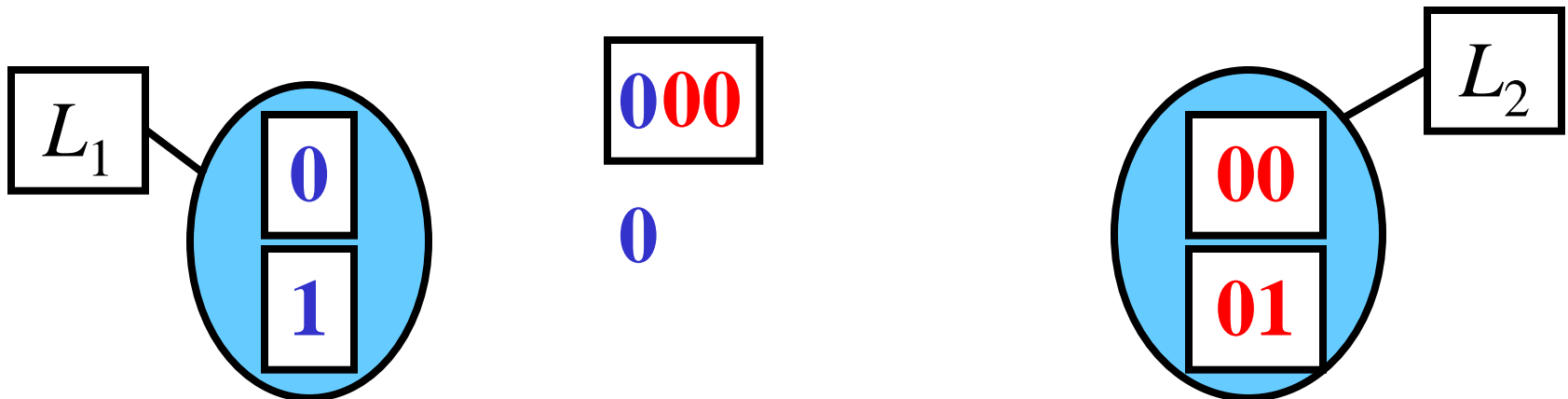

Concatenation of Languages

Gist: $L_1L_2 = \{xy: x \in L_1 \text{ and } y \in L_2\}$

Definition: Let L_1 and L_2 be two languages over Σ . The *concatenation* of L_1 and L_2 , L_1L_2 , is defined as

$$L_1L_2 = \{xy: x \in L_1 \text{ and } y \in L_2\}$$

Note: 1) $L\{\varepsilon\} = \{\varepsilon\}L = L$ 2) $L\emptyset = \emptyset L = \emptyset$

Example: Consider languages $L_1 = \{0, 1\}$, $L_2 = \{00, 01\}$

Task: L_1L_2

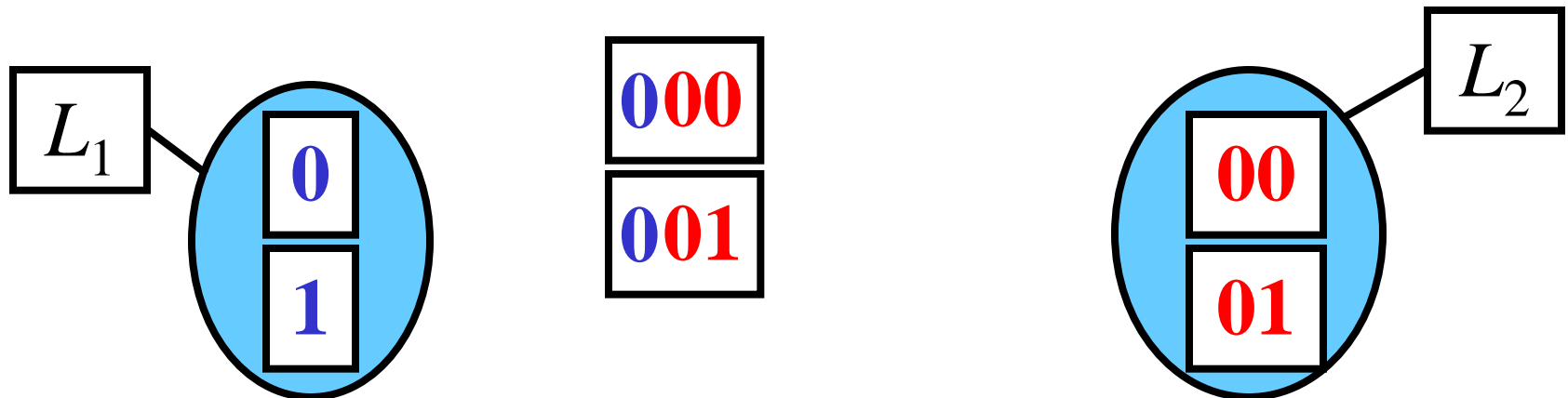

Concatenation of Languages

Gist: $L_1L_2 = \{xy: x \in L_1 \text{ and } y \in L_2\}$

Definition: Let L_1 and L_2 be two languages over Σ . The *concatenation* of L_1 and L_2 , L_1L_2 , is defined as

$$L_1L_2 = \{xy: x \in L_1 \text{ and } y \in L_2\}$$

Note: 1) $L\{\varepsilon\} = \{\varepsilon\}L = L$ 2) $L\emptyset = \emptyset L = \emptyset$

Example: Consider languages $L_1 = \{0, 1\}$, $L_2 = \{00, 01\}$

Task: L_1L_2

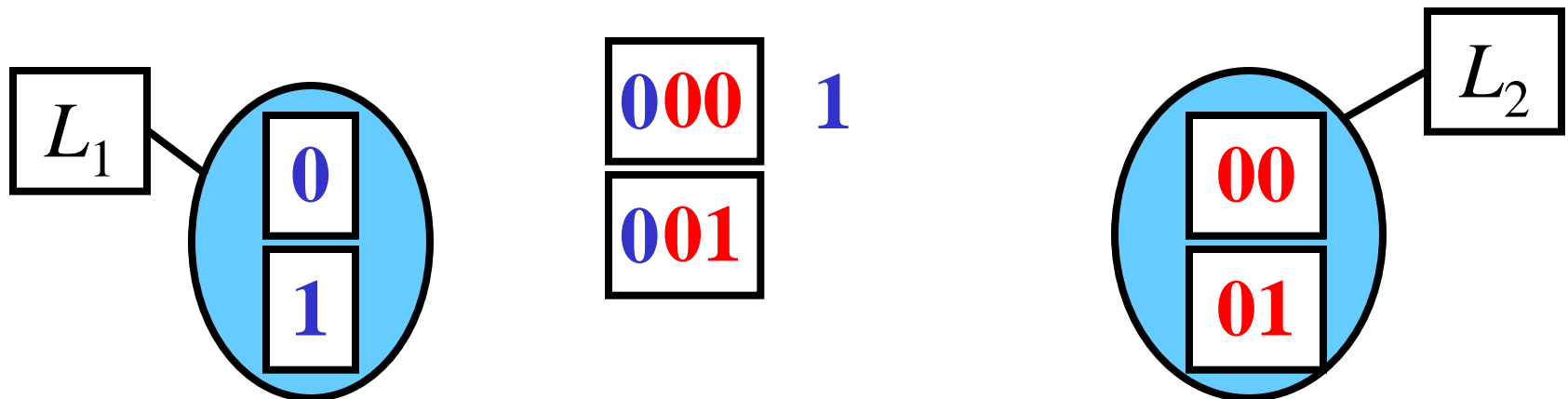

Concatenation of Languages

Gist: $L_1L_2 = \{xy: x \in L_1 \text{ and } y \in L_2\}$

Definition: Let L_1 and L_2 be two languages over Σ . The *concatenation* of L_1 and L_2 , L_1L_2 , is defined as

$$L_1L_2 = \{xy: x \in L_1 \text{ and } y \in L_2\}$$

Note: 1) $L\{\varepsilon\} = \{\varepsilon\}L = L$ 2) $L\emptyset = \emptyset L = \emptyset$

Example: Consider languages $L_1 = \{0, 1\}$, $L_2 = \{00, 01\}$

Task: L_1L_2

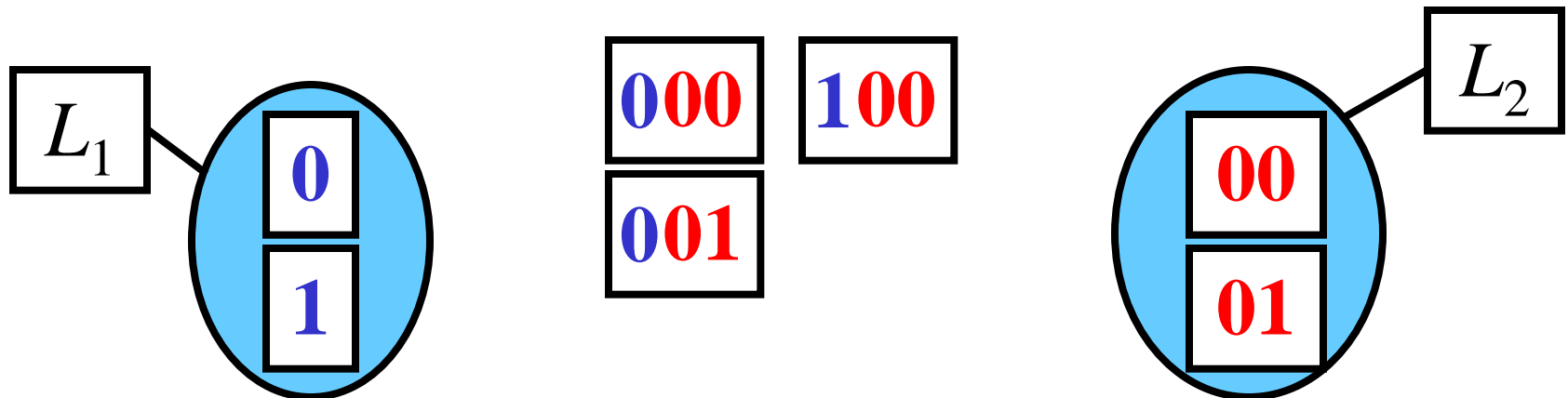

Concatenation of Languages

Gist: $L_1L_2 = \{xy: x \in L_1 \text{ and } y \in L_2\}$

Definition: Let L_1 and L_2 be two languages over Σ . The *concatenation* of L_1 and L_2 , L_1L_2 , is defined as

$$L_1L_2 = \{xy: x \in L_1 \text{ and } y \in L_2\}$$

Note: 1) $L\{\varepsilon\} = \{\varepsilon\}L = L$ 2) $L\emptyset = \emptyset L = \emptyset$

Example: Consider languages $L_1 = \{0, 1\}$, $L_2 = \{00, 01\}$

Task: L_1L_2

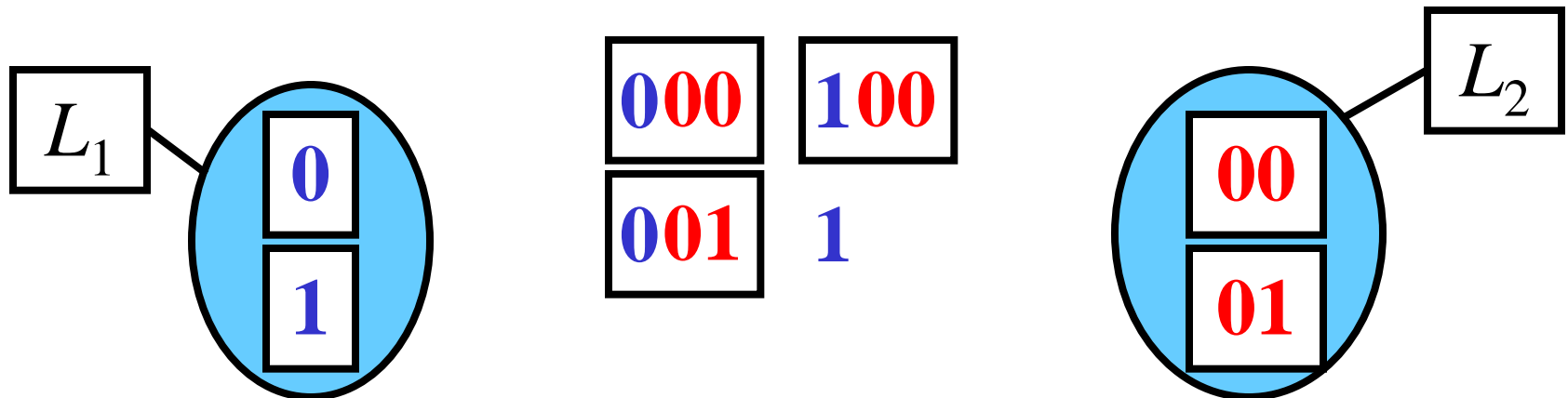

Concatenation of Languages

Gist: $L_1L_2 = \{xy: x \in L_1 \text{ and } y \in L_2\}$

Definition: Let L_1 and L_2 be two languages over Σ . The *concatenation* of L_1 and L_2 , L_1L_2 , is defined as

$$L_1L_2 = \{xy: x \in L_1 \text{ and } y \in L_2\}$$

Note: 1) $L\{\varepsilon\} = \{\varepsilon\}L = L$ 2) $L\emptyset = \emptyset L = \emptyset$

Example: Consider languages $L_1 = \{0, 1\}$, $L_2 = \{00, 01\}$

Task: L_1L_2

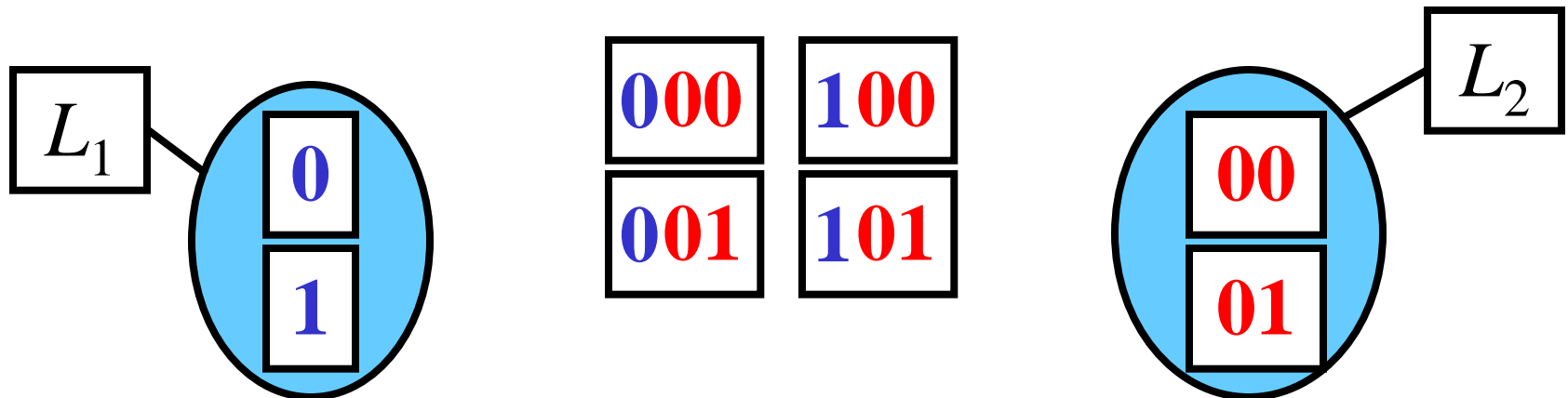

Concatenation of Languages

Gist: $L_1L_2 = \{xy: x \in L_1 \text{ and } y \in L_2\}$

Definition: Let L_1 and L_2 be two languages over Σ . The *concatenation* of L_1 and L_2 , L_1L_2 , is defined as

$$L_1L_2 = \{xy: x \in L_1 \text{ and } y \in L_2\}$$

Note: 1) $L\{\varepsilon\} = \{\varepsilon\}L = L$ 2) $L\emptyset = \emptyset L = \emptyset$

Example: Consider languages $L_1 = \{0, 1\}$, $L_2 = \{00, 01\}$

Task: L_1L_2

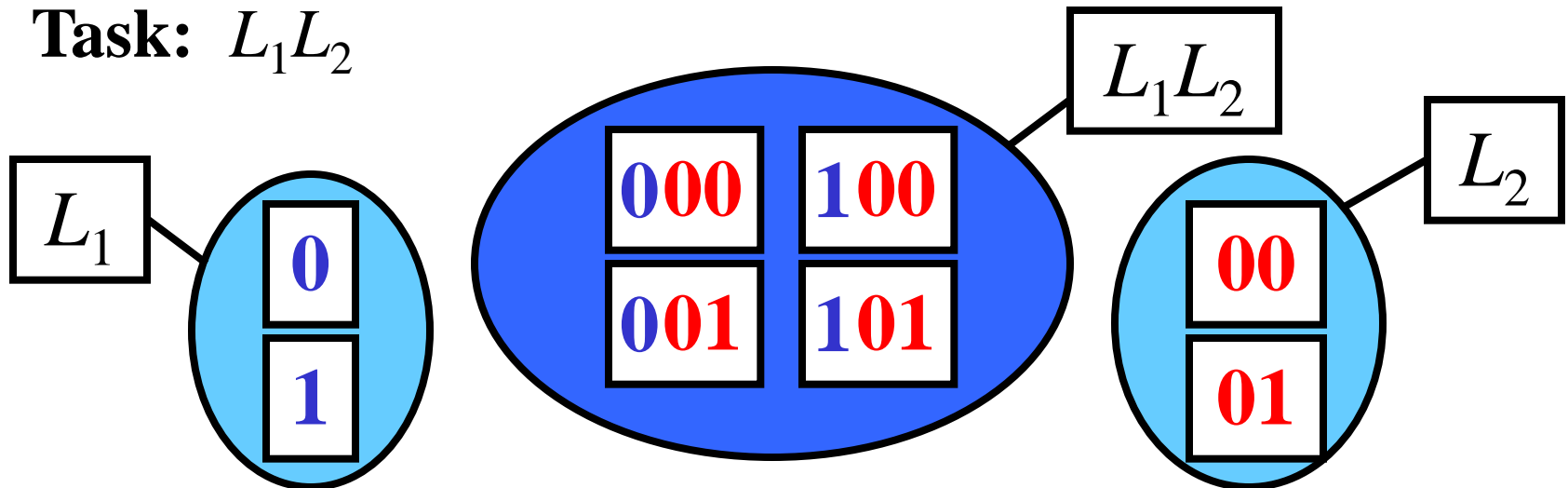

Reversal of Language

Gist: $\text{reversal}(L) = \{\text{reversal}(x) : x \in L\}$

Definition: Let L be a language over Σ .
The *reversal* of L , $\text{reversal}(L)$, is defined as
$$\text{reversal}(L) = \{\text{reversal}(x) : x \in L\}$$

Example: Consider $L = \{01, 011\}$

Task: $\text{reversal}(L)$

Reversal of Language

Gist: $\text{reversal}(L) = \{\text{reversal}(x) : x \in L\}$

Definition: Let L be a language over Σ .
The *reversal* of L , $\text{reversal}(L)$, is defined as
$$\text{reversal}(L) = \{\text{reversal}(x) : x \in L\}$$

Example: Consider $L = \{01, 011\}$

Task: $\text{reversal}(L)$

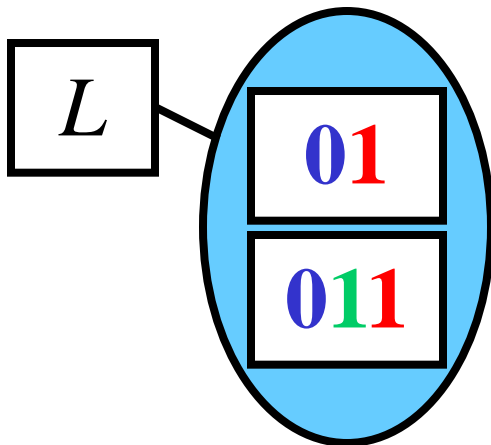

Reversal of Language

Gist: $\text{reversal}(L) = \{\text{reversal}(x) : x \in L\}$

Definition: Let L be a language over Σ .
The *reversal* of L , $\text{reversal}(L)$, is defined as
$$\text{reversal}(L) = \{\text{reversal}(x) : x \in L\}$$

Example: Consider $L = \{01, 011\}$

Task: $\text{reversal}(L)$

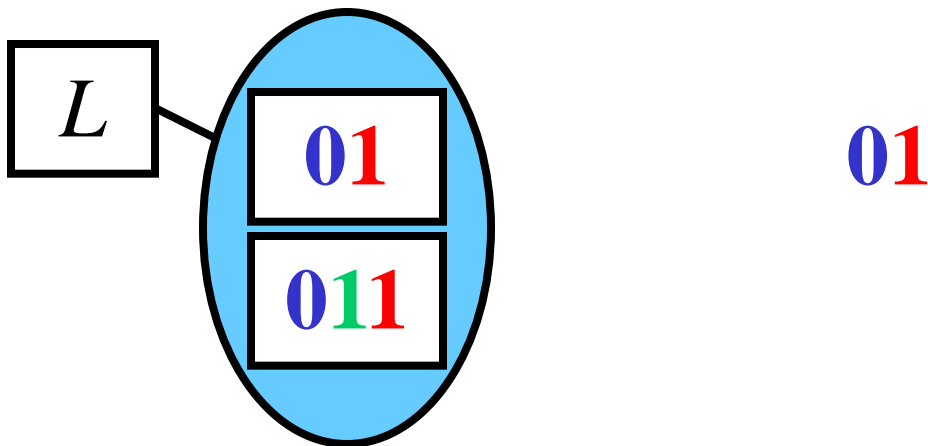

Reversal of Language

Gist: $\text{reversal}(L) = \{\text{reversal}(x) : x \in L\}$

Definition: Let L be a language over Σ .
The *reversal* of L , $\text{reversal}(L)$, is defined as
$$\text{reversal}(L) = \{\text{reversal}(x) : x \in L\}$$

Example: Consider $L = \{01, 011\}$

Task: $\text{reversal}(L)$

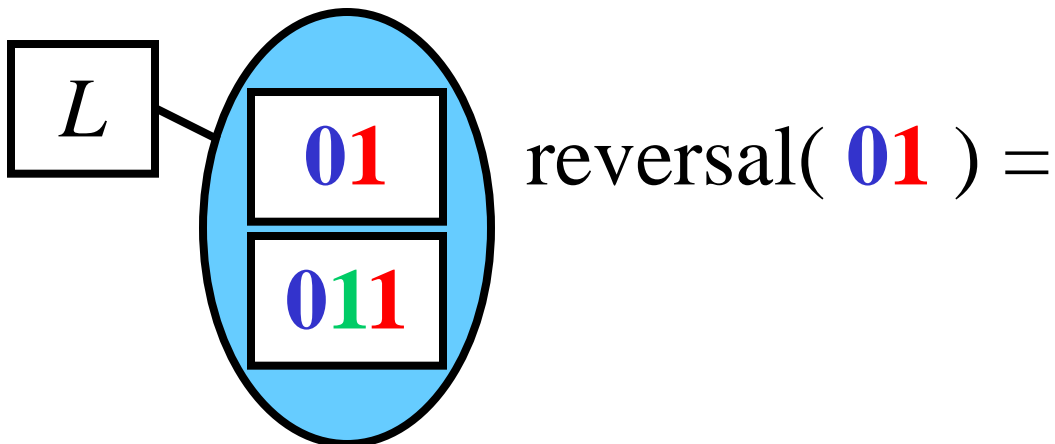

Reversal of Language

Gist: $\text{reversal}(L) = \{\text{reversal}(x) : x \in L\}$

Definition: Let L be a language over Σ .
The *reversal* of L , $\text{reversal}(L)$, is defined as
$$\text{reversal}(L) = \{\text{reversal}(x) : x \in L\}$$

Example: Consider $L = \{01, 011\}$

Task: $\text{reversal}(L)$

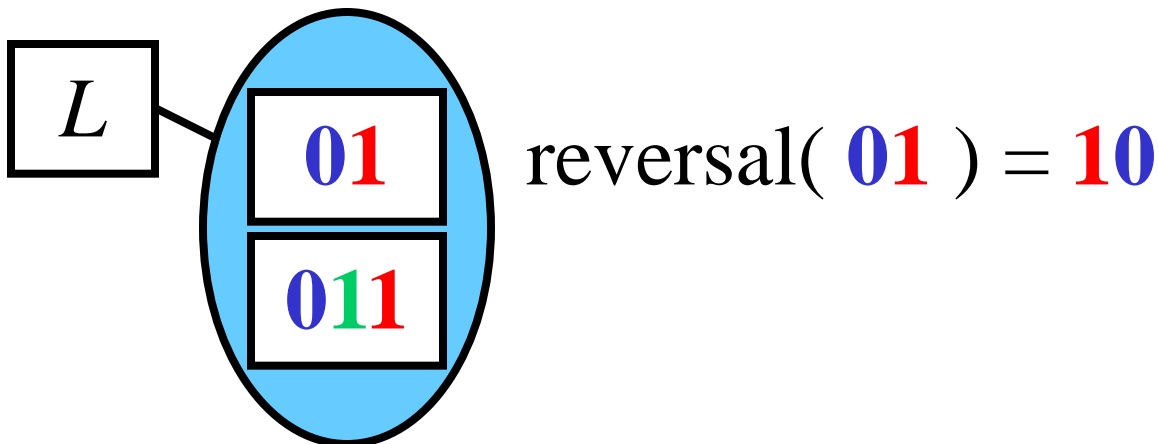

Reversal of Language

Gist: $\text{reversal}(L) = \{\text{reversal}(x) : x \in L\}$

Definition: Let L be a language over Σ .
The *reversal* of L , $\text{reversal}(L)$, is defined as
$$\text{reversal}(L) = \{\text{reversal}(x) : x \in L\}$$

Example: Consider $L = \{01, 011\}$

Task: $\text{reversal}(L)$

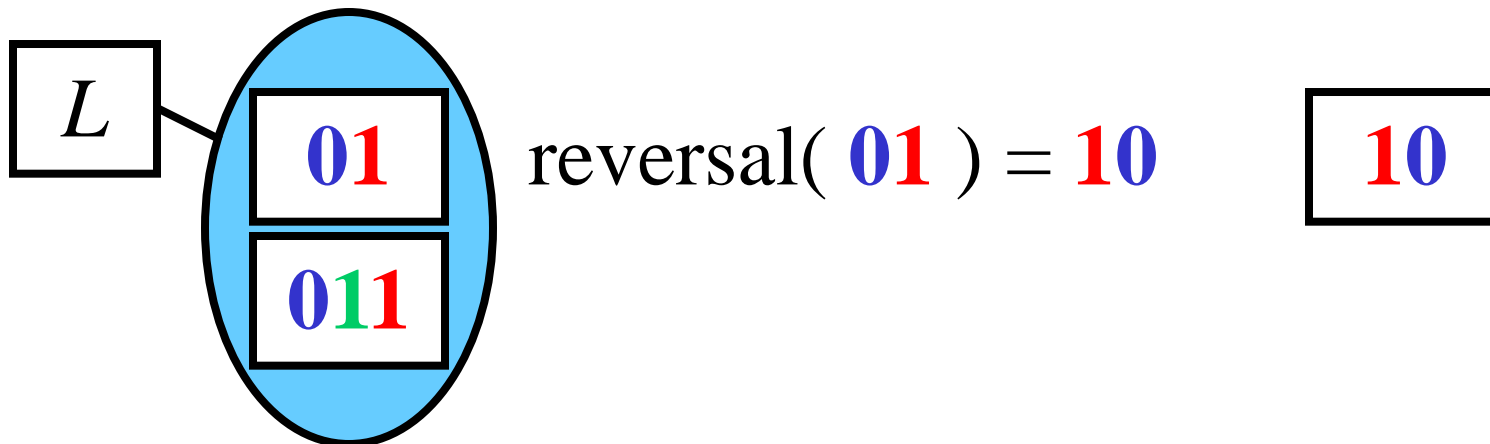

Reversal of Language

Gist: $\text{reversal}(L) = \{\text{reversal}(x) : x \in L\}$

Definition: Let L be a language over Σ .
The *reversal* of L , $\text{reversal}(L)$, is defined as
$$\text{reversal}(L) = \{\text{reversal}(x) : x \in L\}$$

Example: Consider $L = \{01, 011\}$

Task: $\text{reversal}(L)$

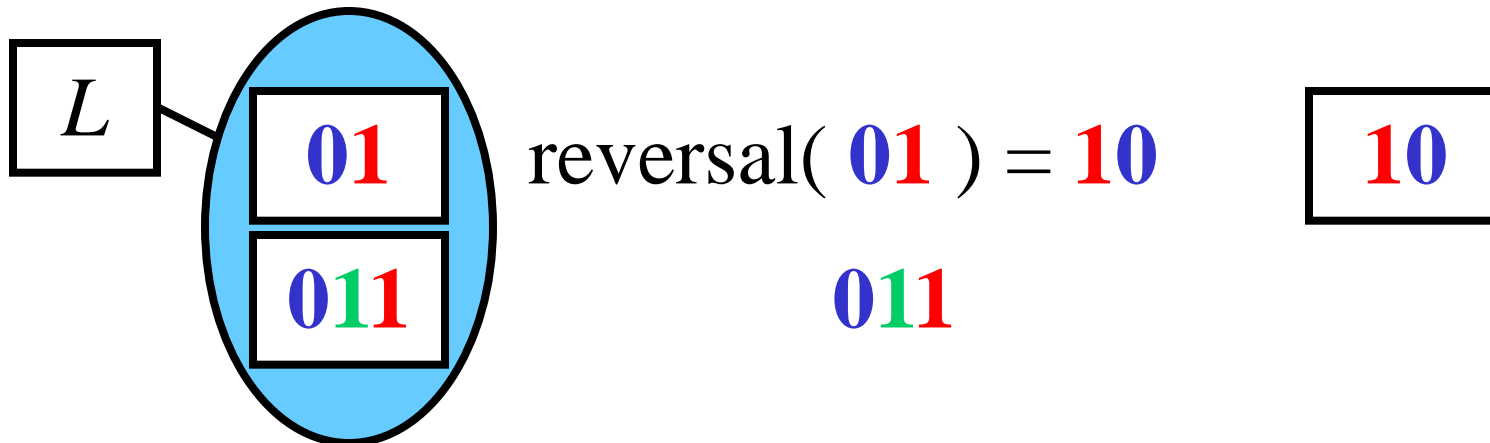

Reversal of Language

Gist: $\text{reversal}(L) = \{\text{reversal}(x) : x \in L\}$

Definition: Let L be a language over Σ .
The *reversal* of L , $\text{reversal}(L)$, is defined as
$$\text{reversal}(L) = \{\text{reversal}(x) : x \in L\}$$

Example: Consider $L = \{01, 011\}$

Task: $\text{reversal}(L)$

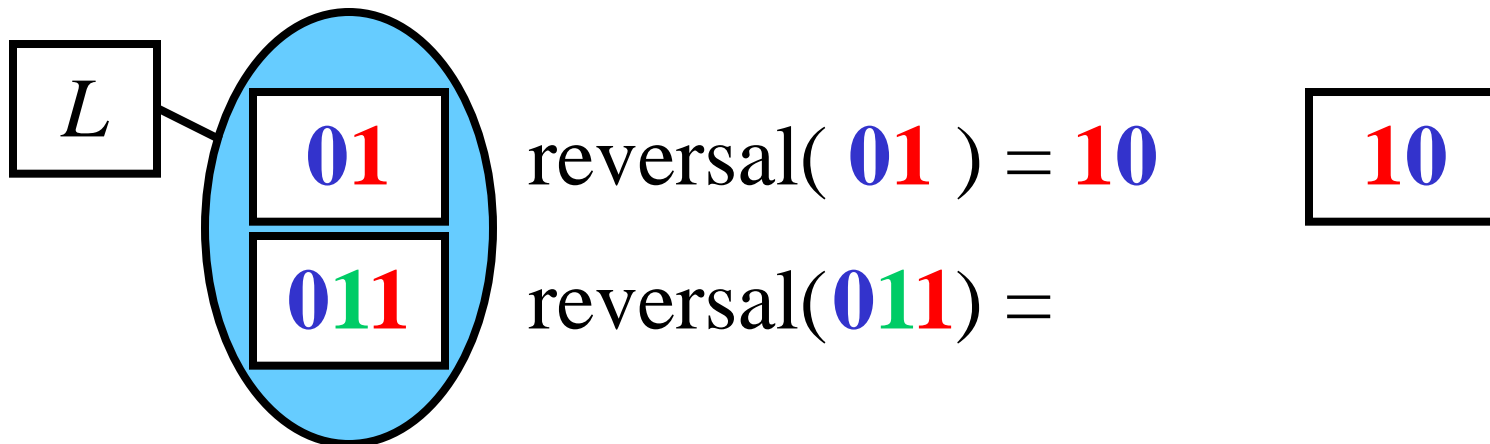

Reversal of Language

Gist: $reversal(L) = \{reversal(x) : x \in L\}$

Definition: Let L be a language over Σ .
The *reversal* of L , $reversal(L)$, is defined as
 $reversal(L) = \{reversal(x) : x \in L\}$

Example: Consider $L = \{01, 011\}$

Task: $reversal(L)$

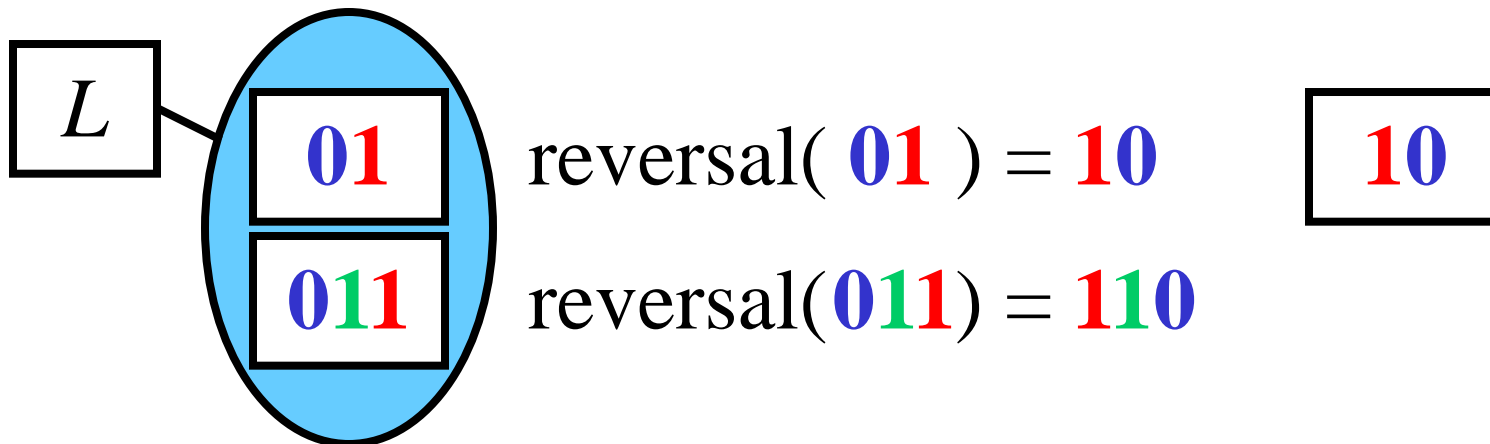

Reversal of Language

Gist: $\text{reversal}(L) = \{\text{reversal}(x) : x \in L\}$

Definition: Let L be a language over Σ .
The *reversal* of L , $\text{reversal}(L)$, is defined as
$$\text{reversal}(L) = \{\text{reversal}(x) : x \in L\}$$

Example: Consider $L = \{01, 011\}$

Task: $\text{reversal}(L)$

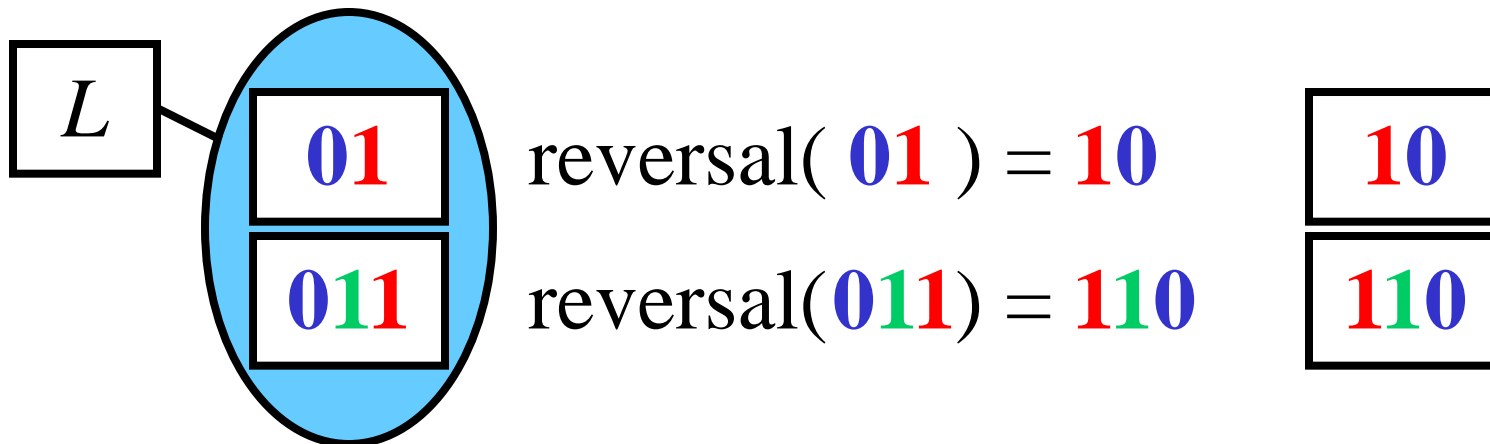

Reversal of Language

Gist: $reversal(L) = \{reversal(x) : x \in L\}$

Definition: Let L be a language over Σ .
The *reversal* of L , $reversal(L)$, is defined as
 $reversal(L) = \{reversal(x) : x \in L\}$

Example: Consider $L = \{01, 011\}$

Task: $reversal(L)$

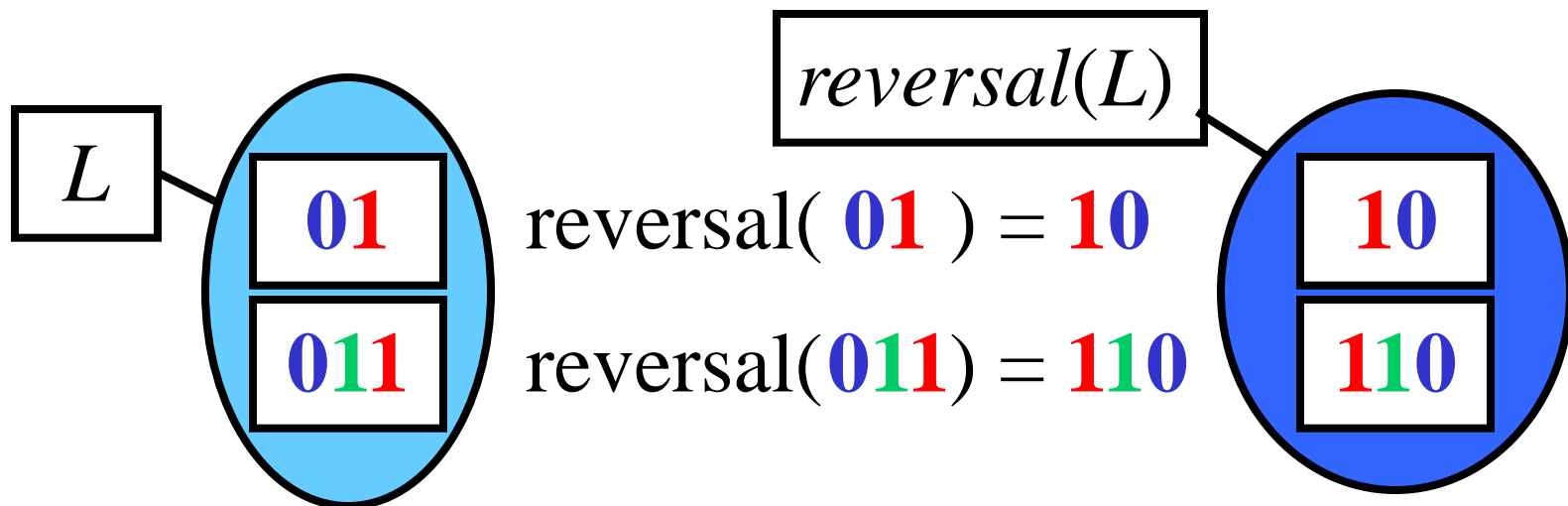

Power of Language

Gist: $L^i = \underbrace{LL\dots L}_{i\text{-times}}$

Definition: Let L be a language over Σ .

For $i \geq 0$, the i -th *power* of L , L^i , is defined as:

1) $L^0 = \{\varepsilon\}$ 2) if $i \geq 1$ then $L^i = LL^{i-1}$

Example: Consider $L = \{0, 01\}$

Task: L^2

Power of Language

Gist: $L^i = \underbrace{LL\dots L}_{i\text{-times}}$

Definition: Let L be a language over Σ .

For $i \geq 0$, the i -th *power* of L , L^i , is defined as:

1) $L^0 = \{\varepsilon\}$ 2) if $i \geq 1$ then $L^i = LL^{i-1}$

Example: Consider $L = \{0, 01\}$

Task: L^2

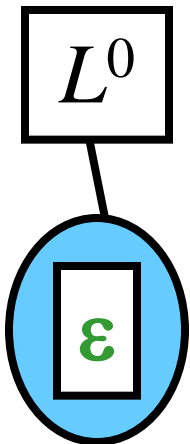

Power of Language

Gist: $L^i = \underbrace{LL\dots L}_{i\text{-times}}$

Definition: Let L be a language over Σ .

For $i \geq 0$, the i -th *power* of L , L^i , is defined as:

1) $L^0 = \{\varepsilon\}$ 2) if $i \geq 1$ then $L^i = LL^{i-1}$

Example: Consider $L = \{0, 01\}$

Task: L^2

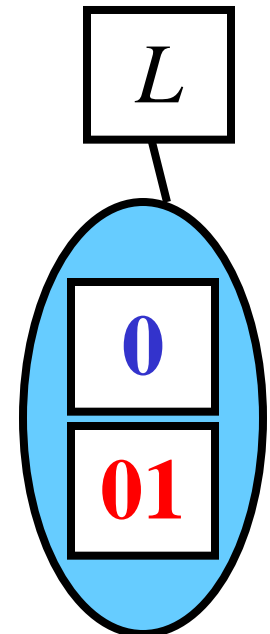
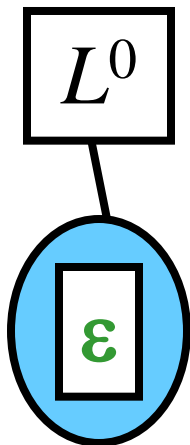

Power of Language

Gist: $L^i = \underbrace{LL\dots L}_{i\text{-times}}$

Definition: Let L be a language over Σ .

For $i \geq 0$, the i -th *power* of L , L^i , is defined as:

1) $L^0 = \{\varepsilon\}$ 2) if $i \geq 1$ then $L^i = LL^{i-1}$

Example: Consider $L = \{0, 01\}$

Task: L^2

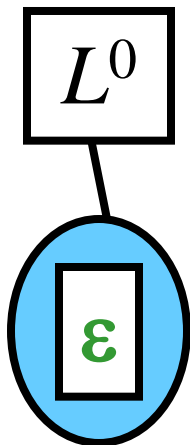

ε

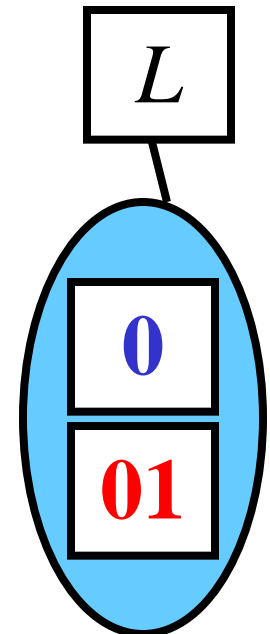

Power of Language

Gist: $L^i = \underbrace{LL\dots L}_{i\text{-times}}$

Definition: Let L be a language over Σ .

For $i \geq 0$, the i -th *power* of L , L^i , is defined as:

1) $L^0 = \{\varepsilon\}$ 2) if $i \geq 1$ then $L^i = LL^{i-1}$

Example: Consider $L = \{0, 01\}$

Task: L^2



Power of Language

Gist: $L^i = \underbrace{LL\dots L}_{i\text{-times}}$

Definition: Let L be a language over Σ .

For $i \geq 0$, the i -th *power* of L , L^i , is defined as:

1) $L^0 = \{\varepsilon\}$ 2) if $i \geq 1$ then $L^i = LL^{i-1}$

Example: Consider $L = \{0, 01\}$

Task: L^2



Power of Language

Gist: $L^i = \underbrace{LL\dots L}_{i\text{-times}}$

Definition: Let L be a language over Σ .

For $i \geq 0$, the i -th *power* of L , L^i , is defined as:

1) $L^0 = \{\varepsilon\}$ 2) if $i \geq 1$ then $L^i = LL^{i-1}$

Example: Consider $L = \{0, 01\}$

Task: L^2

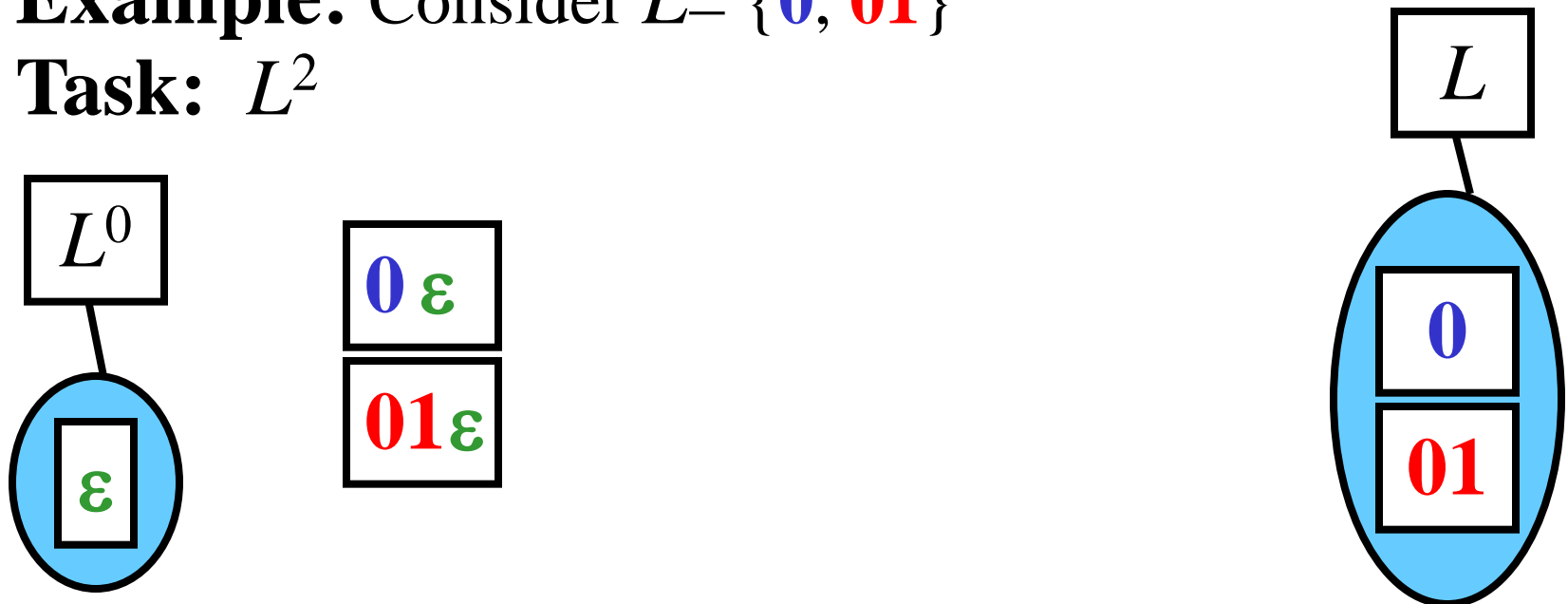

Power of Language

Gist: $L^i = \underbrace{LL\dots L}_{i\text{-times}}$

Definition: Let L be a language over Σ .

For $i \geq 0$, the i -th *power* of L , L^i , is defined as:

1) $L^0 = \{\varepsilon\}$ 2) if $i \geq 1$ then $L^i = LL^{i-1}$

Example: Consider $L = \{0, 01\}$

Task: L^2



Power of Language

Gist: $L^i = \underbrace{LL\dots L}_{i\text{-times}}$

Definition: Let L be a language over Σ .

For $i \geq 0$, the i -th *power* of L , L^i , is defined as:

1) $L^0 = \{\varepsilon\}$

2) if $i \geq 1$ then $L^i = LL^{i-1}$

Example: Consider $L = \{0, 01\}$

Task: L^2

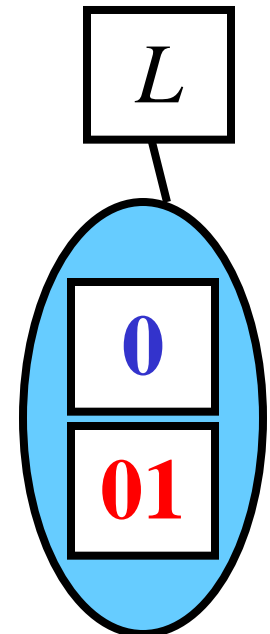
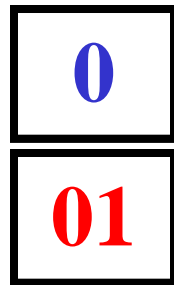
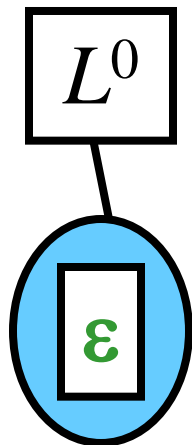

Power of Language

Gist: $L^i = \underbrace{LL\dots L}_{i\text{-times}}$

Definition: Let L be a language over Σ .

For $i \geq 0$, the i -th *power* of L , L^i , is defined as:

1) $L^0 = \{\varepsilon\}$ 2) if $i \geq 1$ then $L^i = LL^{i-1}$

Example: Consider $L = \{0, 01\}$

Task: L^2

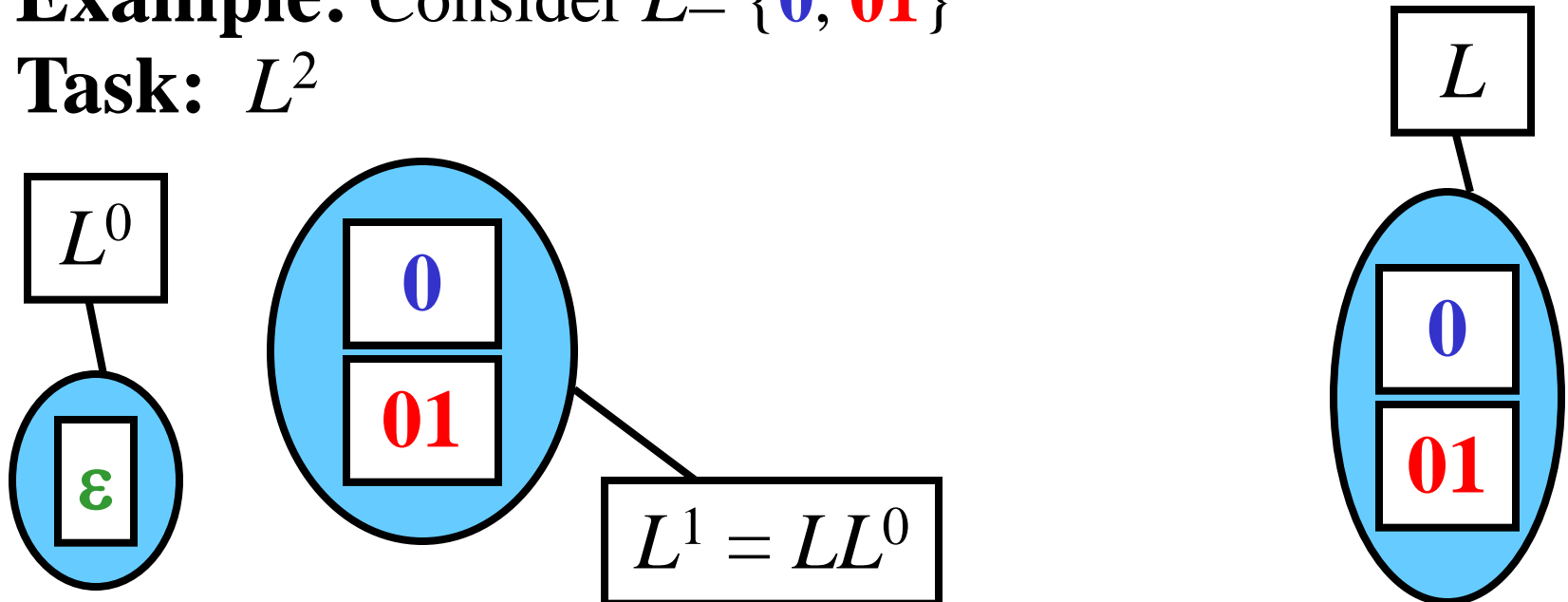

Power of Language

Gist: $L^i = \underbrace{LL\dots L}_{i\text{-times}}$

Definition: Let L be a language over Σ .

For $i \geq 0$, the i -th *power* of L , L^i , is defined as:

1) $L^0 = \{\varepsilon\}$

2) if $i \geq 1$ then $L^i = LL^{i-1}$

Example: Consider $L = \{0, 01\}$

Task: L^2

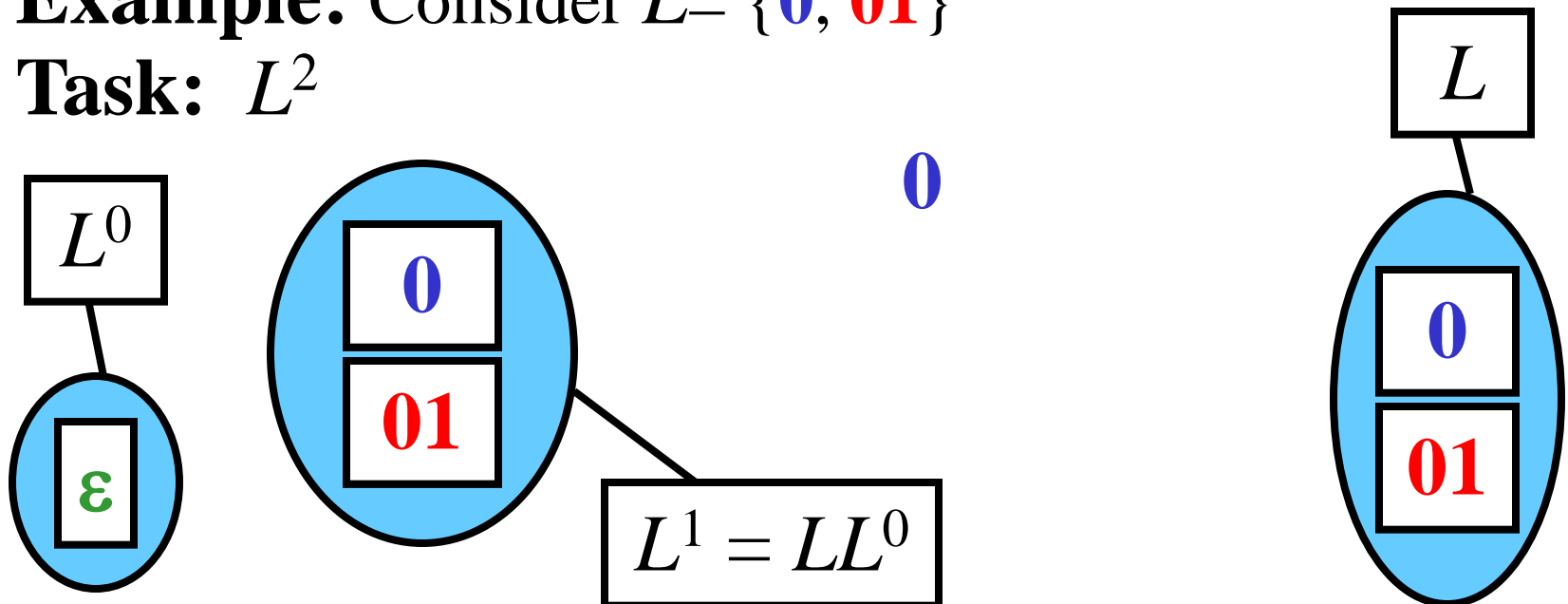

Power of Language

Gist: $L^i = \underbrace{LL\dots L}_{i\text{-times}}$

Definition: Let L be a language over Σ .

For $i \geq 0$, the i -th *power* of L , L^i , is defined as:

1) $L^0 = \{\varepsilon\}$ 2) if $i \geq 1$ then $L^i = LL^{i-1}$

Example: Consider $L = \{0, 01\}$

Task: L^2

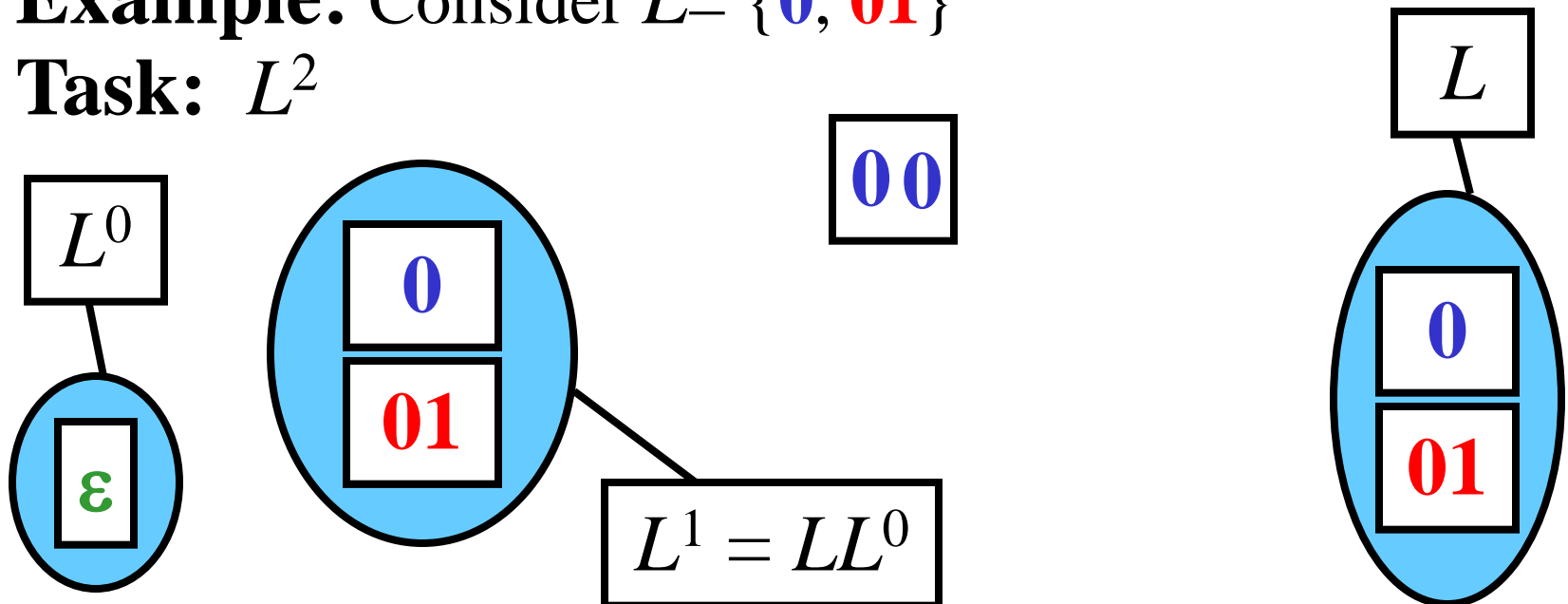

Power of Language

Gist: $L^i = \underbrace{LL\dots L}_{i\text{-times}}$

Definition: Let L be a language over Σ .

For $i \geq 0$, the i -th *power* of L , L^i , is defined as:

1) $L^0 = \{\varepsilon\}$ 2) if $i \geq 1$ then $L^i = LL^{i-1}$

Example: Consider $L = \{0, 01\}$

Task: L^2

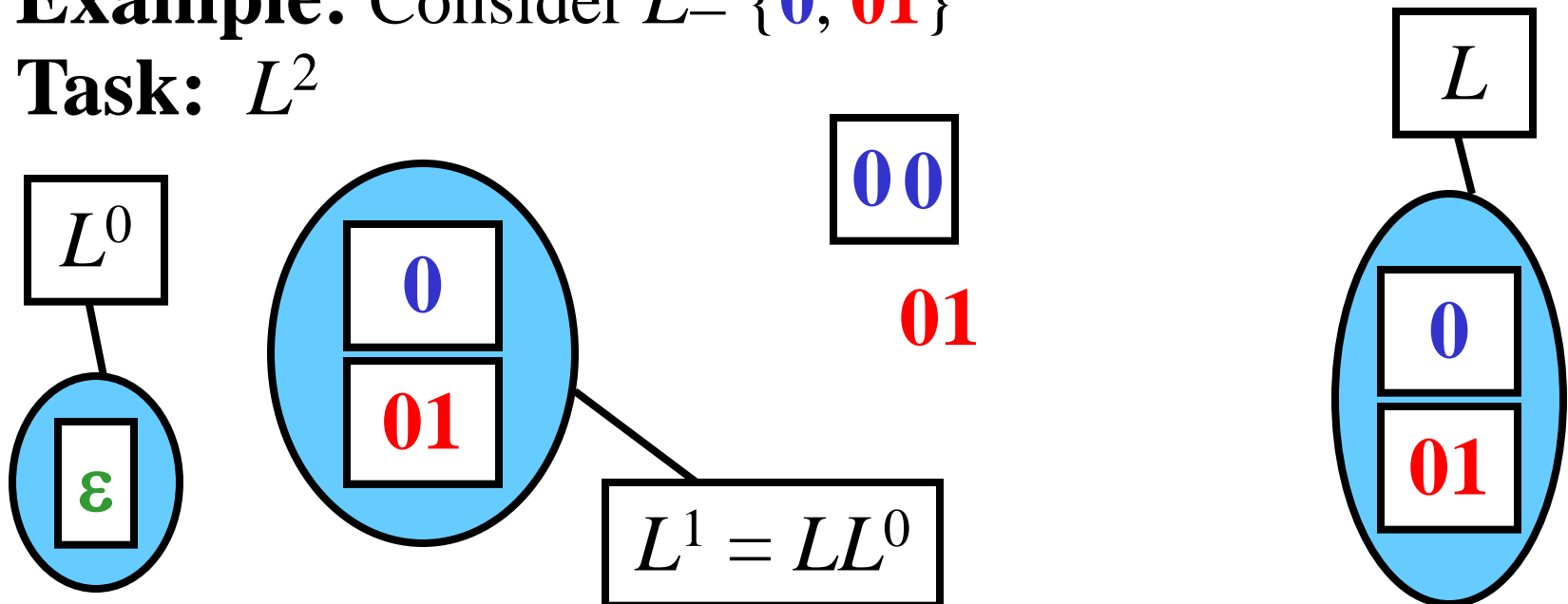

Power of Language

Gist: $L^i = \underbrace{LL\dots L}_{i\text{-times}}$

Definition: Let L be a language over Σ .

For $i \geq 0$, the i -th *power* of L , L^i , is defined as:

1) $L^0 = \{\varepsilon\}$ 2) if $i \geq 1$ then $L^i = LL^{i-1}$

Example: Consider $L = \{0, 01\}$

Task: L^2

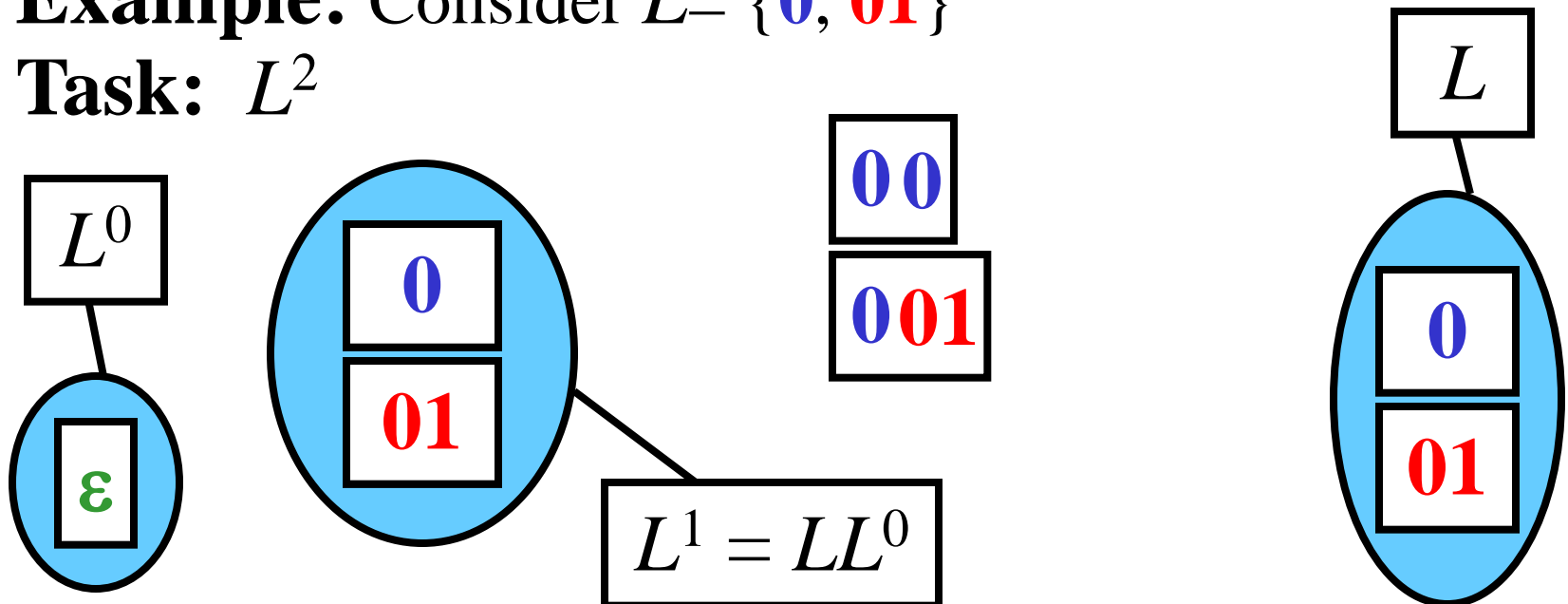

Power of Language

Gist: $L^i = \underbrace{LL\dots L}_{i\text{-times}}$

Definition: Let L be a language over Σ .

For $i \geq 0$, the i -th *power* of L , L^i , is defined as:

1) $L^0 = \{\varepsilon\}$ 2) if $i \geq 1$ then $L^i = LL^{i-1}$

Example: Consider $L = \{0, 01\}$

Task: L^2

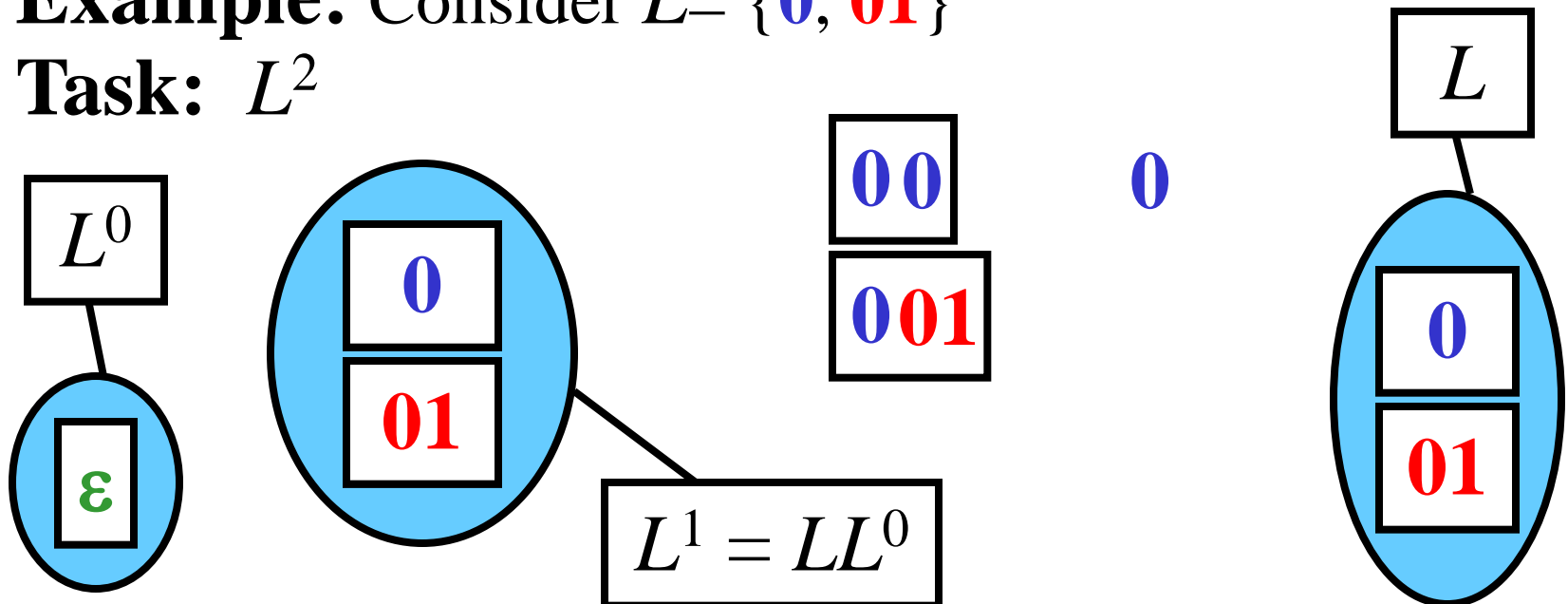

Power of Language

Gist: $L^i = \underbrace{LL\dots L}_{i\text{-times}}$

Definition: Let L be a language over Σ .

For $i \geq 0$, the i -th *power* of L , L^i , is defined as:

1) $L^0 = \{\varepsilon\}$

2) if $i \geq 1$ then $L^i = LL^{i-1}$

Example: Consider $L = \{0, 01\}$

Task: L^2

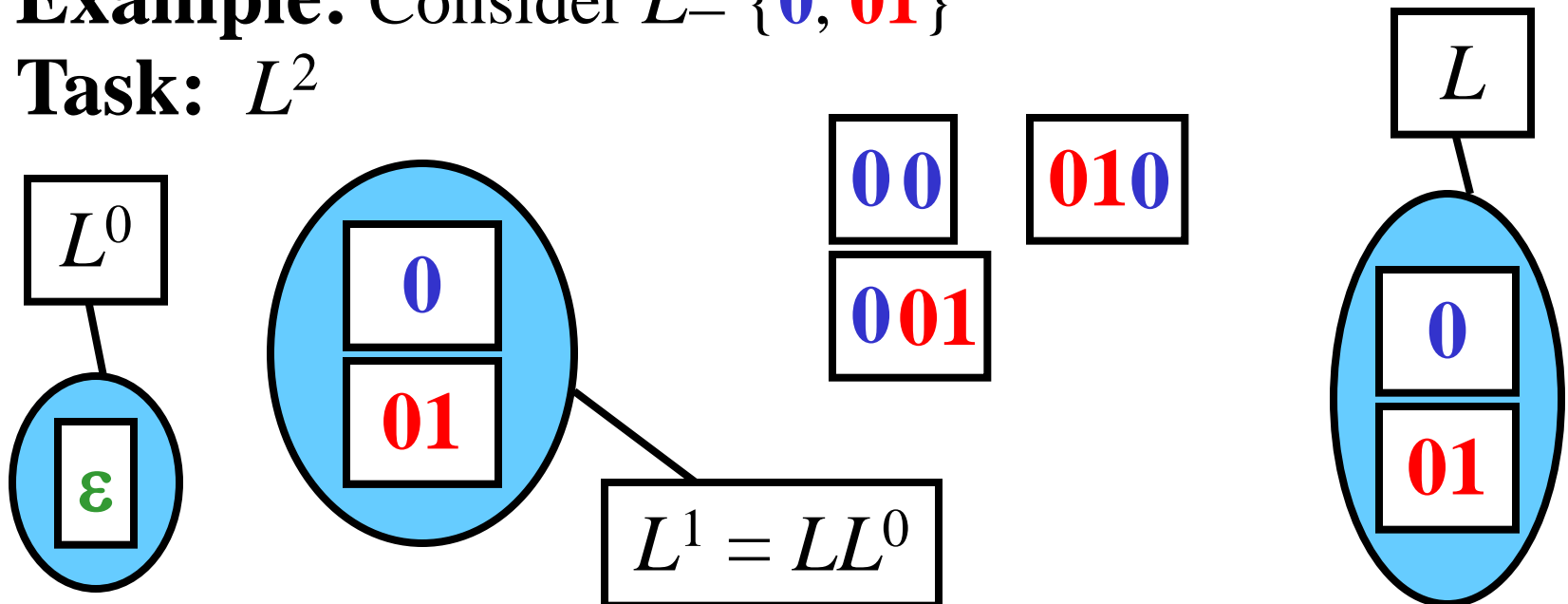

Power of Language

Gist: $L^i = \underbrace{LL\dots L}_{i\text{-times}}$

Definition: Let L be a language over Σ .

For $i \geq 0$, the i -th *power* of L , L^i , is defined as:

1) $L^0 = \{\varepsilon\}$ 2) if $i \geq 1$ then $L^i = LL^{i-1}$

Example: Consider $L = \{0, 01\}$

Task: L^2

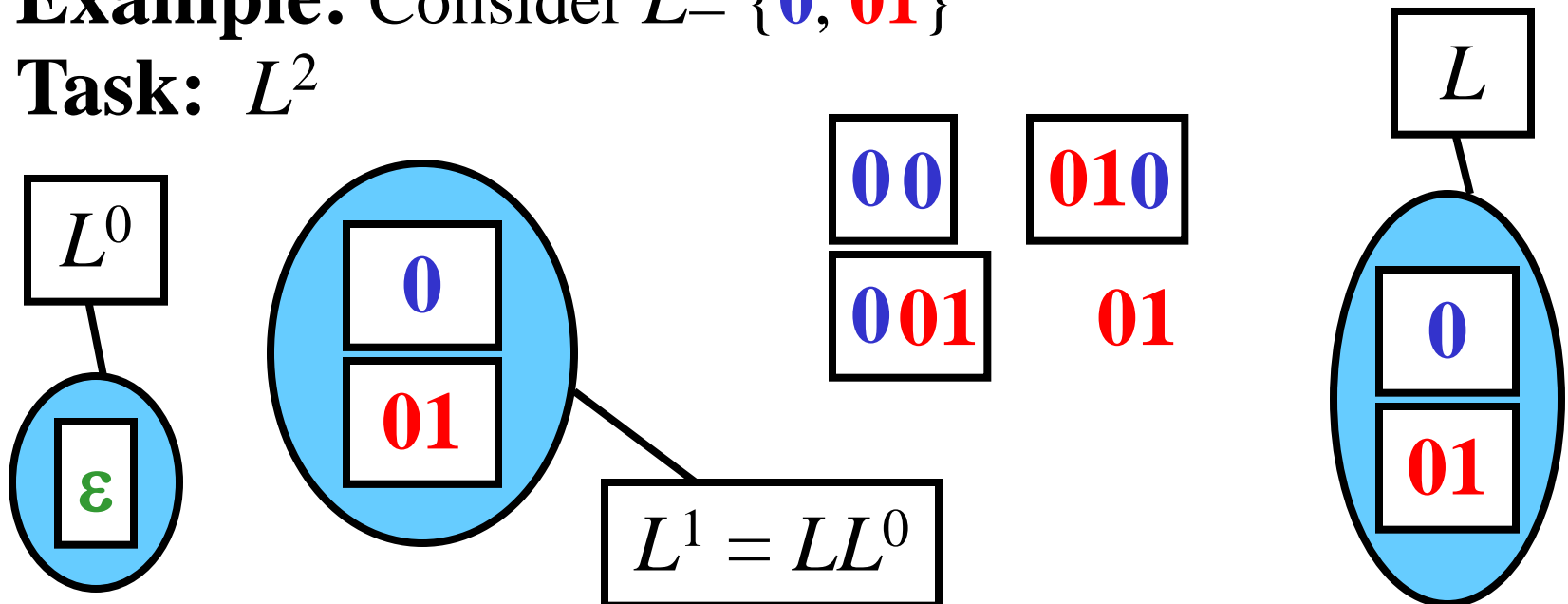

Power of Language

Gist: $L^i = \underbrace{LL\dots L}_{i\text{-times}}$

Definition: Let L be a language over Σ .

For $i \geq 0$, the i -th *power* of L , L^i , is defined as:

- 1) $L^0 = \{\varepsilon\}$ 2) if $i \geq 1$ then $L^i = LL^{i-1}$

Example: Consider $L = \{0, 01\}$

Task: L^2

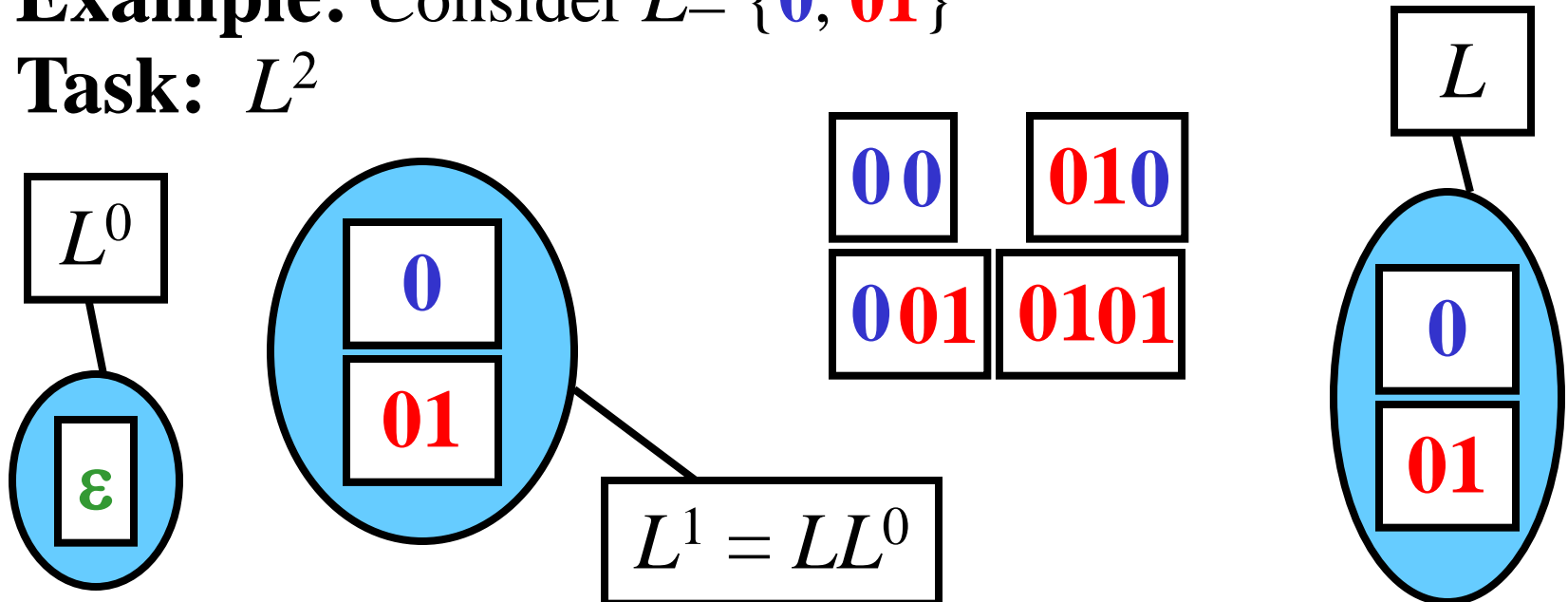

Power of Language

Gist: $L^i = \underbrace{LL\dots L}_{i\text{-times}}$

Definition: Let L be a language over Σ .

For $i \geq 0$, the i -th *power* of L , L^i , is defined as:

1) $L^0 = \{\varepsilon\}$ 2) if $i \geq 1$ then $L^i = LL^{i-1}$

Example: Consider $L = \{0, 01\}$

Task: L^2

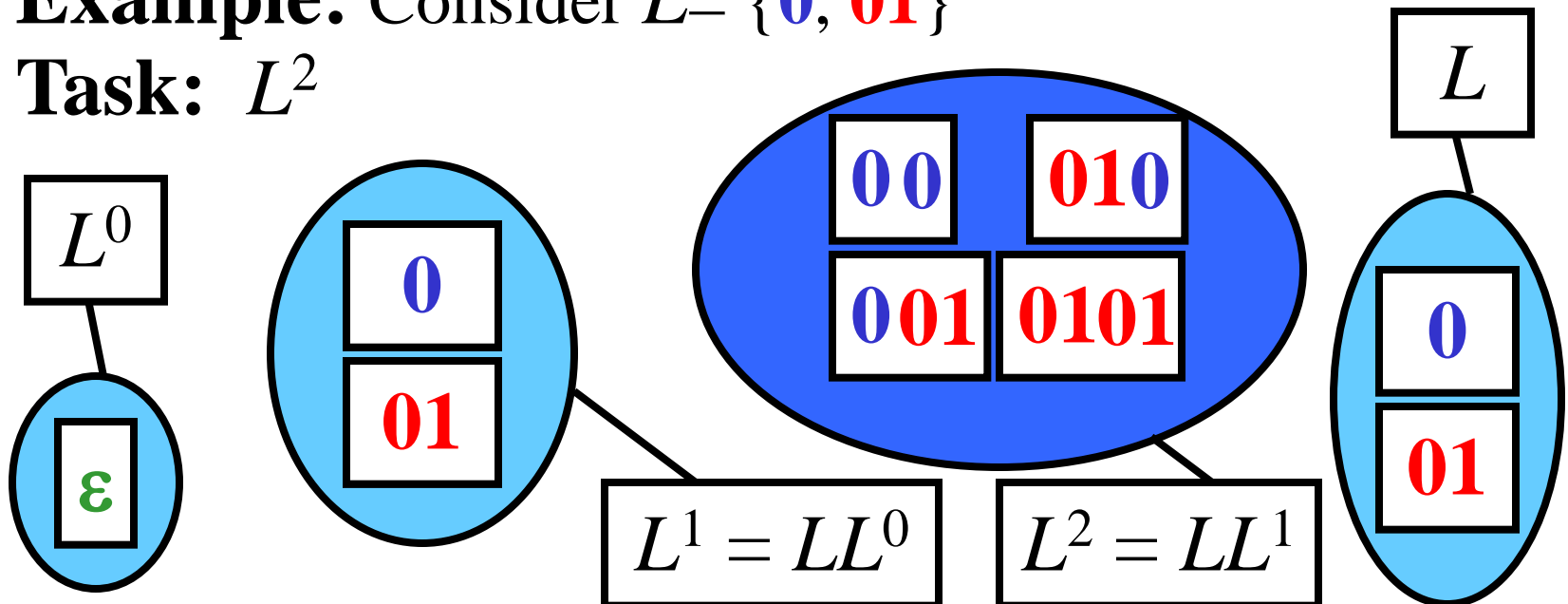

Iteration of Language

Gist: $L^* = L^0 \cup L^1 \cup L^2 \cup \dots \cup L^i \cup \dots$
 $L^+ = L^1 \cup L^2 \cup \dots \cup L^i \cup \dots$

Definition: Let L be a language over Σ . The *iteration* of L , L^* , and the *positive iteration* of L , L^+ , are defined as $L^* = \bigcup_{i=0}^{\infty} L^i$, $L^+ = \bigcup_{i=1}^{\infty} L^i$

Note: 1) $L^+ = LL^* = L^*L$ 2) $L^* = L^+ \cup \{\varepsilon\}$

Example:

Consider language $L = \{0, 01\}$ over $\Sigma = \{0, 1\}$.

Task: L^* and L^+

Iteration of Language

Gist: $L^* = L^0 \cup L^1 \cup L^2 \cup \dots \cup L^i \cup \dots$
 $L^+ = L^1 \cup L^2 \cup \dots \cup L^i \cup \dots$

Definition: Let L be a language over Σ . The *iteration* of L , L^* , and the *positive iteration* of L , L^+ , are defined as $L^* = \bigcup_{i=0}^{\infty} L^i$, $L^+ = \bigcup_{i=1}^{\infty} L^i$

Note: 1) $L^+ = LL^* = L^*L$ 2) $L^* = L^+ \cup \{\varepsilon\}$

Example:

Consider language $L = \{0, 01\}$ over $\Sigma = \{0, 1\}$.

Task: L^* and L^+

$L^0 = \{\varepsilon\}$, $L^1 = \{0, 01\}$, $L^2 = \{00, 001, 010, 0101\}$, ...

$L^* = L^0 \cup L^1 \cup L^2 \cup \dots = \{\varepsilon, 0, 01, 00, 001, 010, 0101, \dots\}$

$L^+ = L^1 \cup L^2 \cup \dots = \{0, 01, 00, 001, 010, 0101, \dots\}$