

Syntax Analysis:

Models

Section 3.1

Context-Free Grammar (CFG)

Gist: A *grammar* is based on a finite set of grammatical rules, by which it generates strings of its language.

Illustration: Start nonterminal

Grammar G :

Nonterminals: A, B, S

Terminals: a, b, c, d

Rules:

- $S \rightarrow AB,$
- $A \rightarrow aAb,$
- $A \rightarrow ab,$
- $B \rightarrow bBa,$
- $B \rightarrow ba$

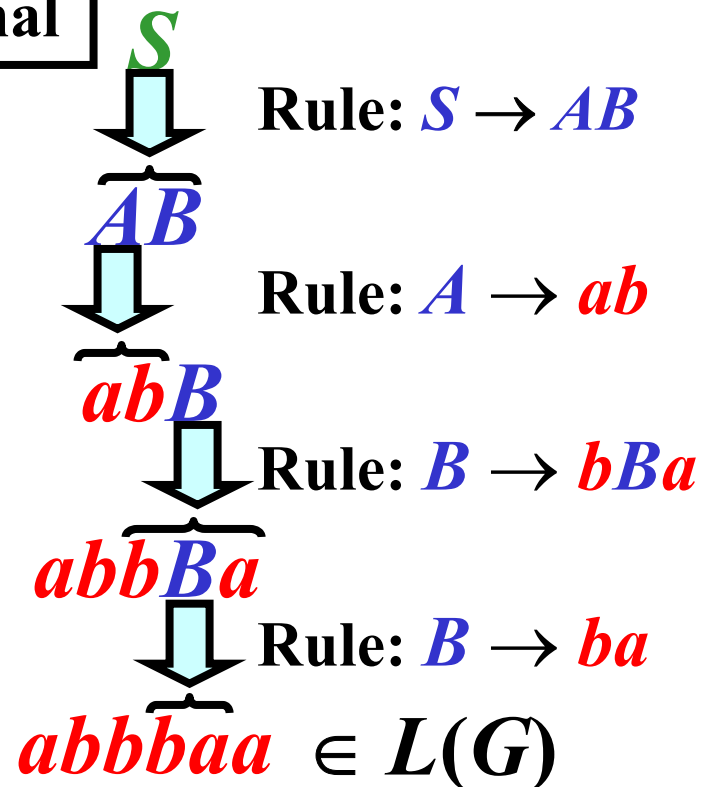

Context-Free Grammar: Definition

Definition: A *context-free grammar* (CFG) is a quadruple $G = (N, T, P, S)$, where

- N is an alphabet of *nonterminals*
- T is an alphabet of *terminals*, $N \cap T = \emptyset$
- P is a finite set of *rules* of the form $A \rightarrow x$, where $A \in N$, $x \in (N \cup T)^*$
- $S \in N$ is the *start nonterminal*

Mathematical Note on Rules:

- Strictly mathematically, P is a relation from N to $(N \cup T)^*$
- Instead of $(A, \mathbf{x}) \in P$, we write $A \rightarrow \mathbf{x} \in P$

- $A \rightarrow \mathbf{x}$ means that A can be replaced with \mathbf{x}
- $A \rightarrow \varepsilon$ is called *ε -rule*

Convention

- A, \dots, F, S : nonterminals
- S : the start nonterminal
- a, \dots, d : terminals
- U, \dots, Z : members of $(N \cup T)$
- u, \dots, z : members of $(N \cup T)^*$
- π : sequence of productions

A subset of rules of the form:

$$A \rightarrow x_1, A \rightarrow x_2, \dots, A \rightarrow x_n$$

can be simply written as:

$$A \rightarrow x_1 \mid x_2 \mid \dots \mid x_n$$

Derivation Step

Gist: A change of a string by a rule.

Definition: Let $G = (N, T, P, S)$ be a CFG. Let $u, v \in (N \cup T)^*$ and $p = A \rightarrow x \in P$. Then, uAv directly derives uxv according to p in G , written as $uAv \Rightarrow uxv [p]$ or, simply, $uAv \Rightarrow uxv$.

Note: If $uAv \Rightarrow uxv$ in G , we also say that G makes a *derivation step* from uAv to uxv .

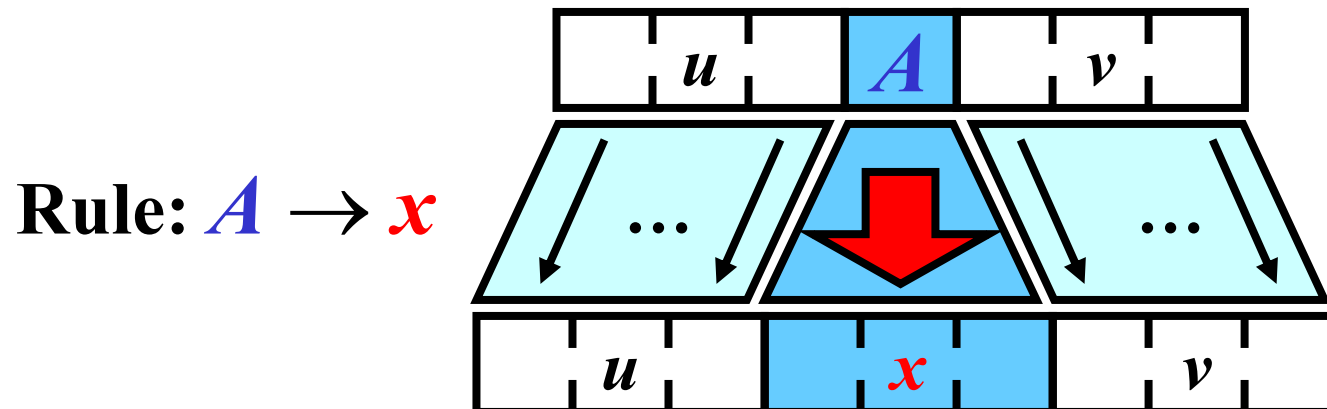

Sequence of Derivation Steps 1/2

Gist: Several consecutive derivation steps.

Definition: Let $u \in (N \cup T)^*$. G makes a *zero-step derivation* from u to u ; in symbols,

$$u \Rightarrow^0 u [\varepsilon] \text{ or, simply, } u \Rightarrow^0 u$$

Definition: Let $u_0, \dots, u_n \in (N \cup T)^*$, $n \geq 1$, and $u_{i-1} \Rightarrow u_i [p_i]$, $p_i \in P$, for all $i = 1, \dots, n$; that is

$$u_0 \Rightarrow u_1 [p_1] \Rightarrow u_2 [p_2] \dots \Rightarrow u_n [p_n]$$

Then, G makes n *derivation steps* from u_0 to u_n ,

$$u_0 \Rightarrow^n u_n [p_1 \dots p_n] \text{ or, simply, } u_0 \Rightarrow^n u_n$$

Sequence of Derivation Steps 2/2

If $u_0 \Rightarrow^n u_n [\pi]$ for some $n \geq 1$, then u_0 *properly derives* u_n in G , written as $u_0 \Rightarrow^+ u_n [\pi]$.

If $u_0 \Rightarrow^n u_n [\pi]$ for some $n \geq 0$, then u_0 *derives* u_n in G , written as $u_0 \Rightarrow^* u_n [\pi]$.

Example: Consider

$aAb \Rightarrow a**A**Bbb$ [1: $A \rightarrow **aBb**$], and

$a**a**Bbb \Rightarrow a**a****c**bb$ [2: $B \rightarrow **c**$].

Then, $a**A**b \Rightarrow^2 a**a****c**bb$ [1 2],

$a**A**b \Rightarrow^+ a**a****c**bb$ [1 2],

$a**A**b \Rightarrow^* a**a****c**bb$ [1 2]

Generated Language

Gist: G generates a terminal string w by a sequence of derivation steps from S to w

Definition: Let $G = (N, T, P, S)$ be a CFG. The language generated by G , $L(G)$, is defined as

$$L(G) = \{w: w \in T^*, S \Rightarrow^* w\}$$

Illustration:

$G = (N, T, P, S)$, let $w = a_1 a_2 \dots a_n$; $a_i \in T$ for $i = 1..n$

if $S \Rightarrow \dots \Rightarrow \dots \Rightarrow \underbrace{a_1 a_2 \dots a_n}_w$ then $w \in L(G)$;

otherwise, $w \notin L(G)$

Context-Free Language (CFL)

Gist: A language generated by a CFG.

Definition: Let L be a language. L is a *context-free language* (CFL) if there exists a context-free grammar that generates L .

Example:

$G = (N, T, P, S)$, where $N = \{S\}$, $T = \{a, b\}$,

$P = \{1: S \rightarrow aSb, 2: S \rightarrow \varepsilon\}$

$S \Rightarrow \varepsilon$ [2] $\rightarrow L(G) = \{a^n b^n : n \geq 0\}$
 $S \Rightarrow aSb$ [1] $\Rightarrow ab$ [2]
 $S \Rightarrow aSb$ [1] $\Rightarrow aaSbb$ [1] $\Rightarrow aabb$ [2]
 \vdots

$L = \{a^n b^n : n \geq 0\}$ is a CFL.

Rule Tree

- Rule tree graphically represents a rule

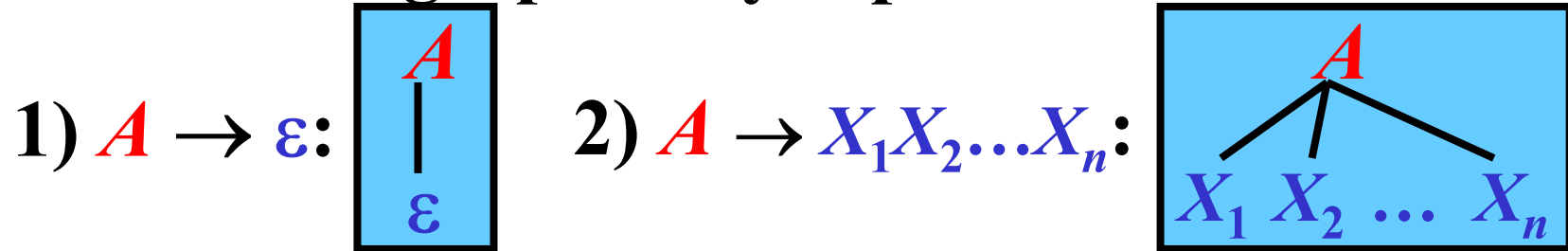

- Derivation tree corresponding to a derivation

$S \Rightarrow \dots$

\vdots

$\Rightarrow U_1 U_2 \dots U_m A V_1 V_2 \dots V_n$

$\Rightarrow U_1 U_2 \dots U_m x V_1 V_2 \dots V_n$

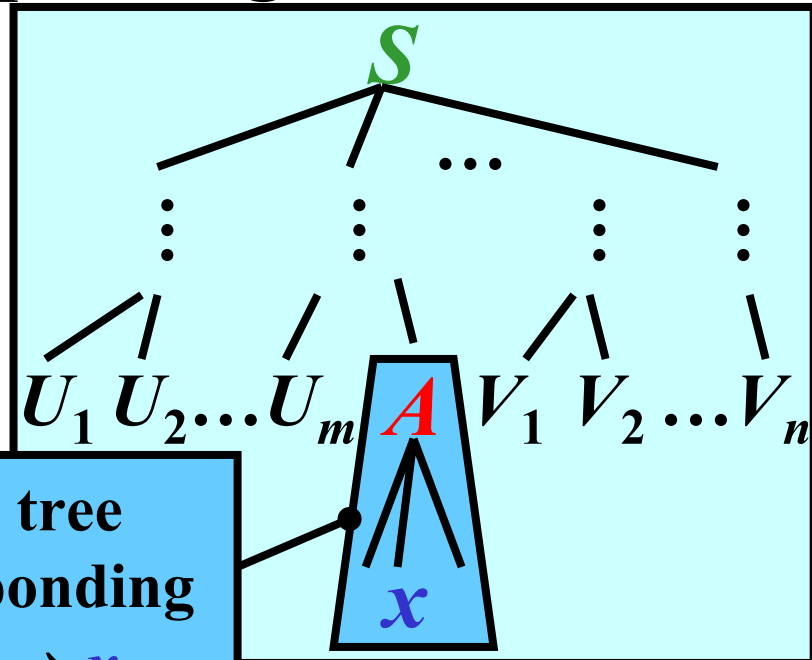

Rule tree
corresponding
to $A \rightarrow x$

Derivation Tree: Example

$G = (N, T, P, \mathbf{E})$, where $N = \{E, F, T\}$, $T = \{i, +, *, (,)\}$,
 $P = \{$ 1: $E \rightarrow E+T$, 2: $E \rightarrow T$, 3: $T \rightarrow T*F$,
4: $T \rightarrow F$, 5: $F \rightarrow (E)$, 6: $F \rightarrow i$ $\}$

Derivation:

$\underline{E} \Rightarrow E + \underline{T}$ [1]
 $\Rightarrow E + \underline{T} * F$ [3]
 $\Rightarrow E + \underline{F} * F$ [4]
 $\Rightarrow \underline{E} + i * F$ [6]
 $\Rightarrow T + i * \underline{E}$ [2]
 $\Rightarrow \underline{T} + i * i$ [6]
 $\Rightarrow \underline{F} + i * i$ [4]
 $\Rightarrow i + i * i$ [6]

Derivation tree:

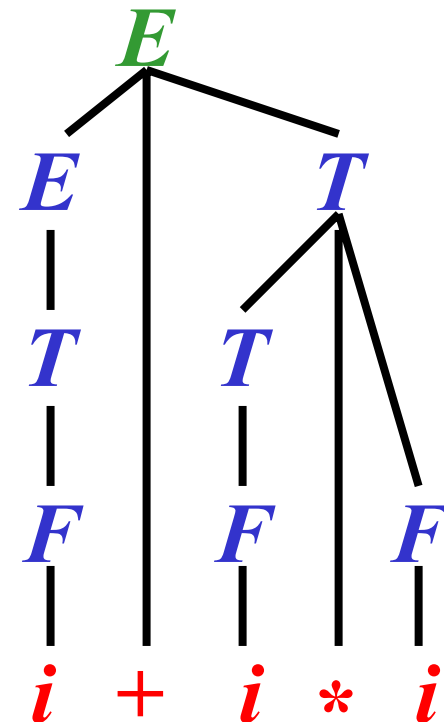

Leftmost Derivation

Gist: During a *leftmost derivation step*, the **leftmost nonterminal is rewritten.**

Definition: Let $G = (N, T, P, S)$ be a CFG, let $u \in T^*$, $v \in (N \cup T)^*$. Let $p = A \rightarrow x \in P$ be a rule. Then, uAv directly derives uxv in the *leftmost way* according to p in G , written as

$$uAv \Rightarrow_{lm} uxv [p]$$

Note: We define \Rightarrow_{lm}^+ and \Rightarrow_{lm}^* by analogy with \Rightarrow^+ and \Rightarrow^* , respectively.

Leftmost Derivation: Example

$G = (N, T, P, \mathbf{E})$, where $N = \{\mathbf{E}, \mathbf{F}, \mathbf{T}\}$, $T = \{\mathbf{i}, +, *, (,)\}$,
 $P = \{$
1: $\mathbf{E} \rightarrow \mathbf{E} + \mathbf{T}$,
2: $\mathbf{E} \rightarrow \mathbf{T}$,
3: $\mathbf{T} \rightarrow \mathbf{T} * \mathbf{F}$,
4: $\mathbf{T} \rightarrow \mathbf{F}$,
5: $\mathbf{F} \rightarrow (\mathbf{E})$,
6: $\mathbf{F} \rightarrow \mathbf{i}$
 $\}$

Leftmost derivation:

$$\begin{aligned}
 \underline{\mathbf{E}} &\Rightarrow_{lm} \underline{\mathbf{E}} + \mathbf{T} && [1] \\
 &\Rightarrow_{lm} \underline{\mathbf{T}} + \mathbf{T} && [2] \\
 &\Rightarrow_{lm} \underline{\mathbf{F}} + \mathbf{T} && [4] \\
 &\Rightarrow_{lm} \mathbf{i} + \underline{\mathbf{T}} && [6] \\
 &\Rightarrow_{lm} \mathbf{i} + \underline{\mathbf{T}} * \mathbf{F} && [3] \\
 &\Rightarrow_{lm} \mathbf{i} + \underline{\mathbf{F}} * \mathbf{F} && [4] \\
 &\Rightarrow_{lm} \mathbf{i} + \mathbf{i} * \underline{\mathbf{E}} && [6] \\
 &\Rightarrow_{lm} \mathbf{i} + \mathbf{i} * \mathbf{i} && [6]
 \end{aligned}$$

Derivation tree:

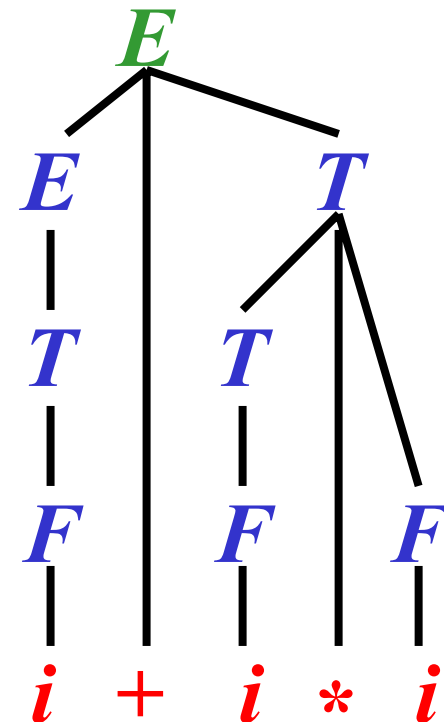

Rightmost Derivation

Gist: During a *rightmost derivation step*, the **rightmost nonterminal is rewritten.**

Definition: Let $G = (N, T, P, S)$ be a CFG, let $u \in (N \cup T)^*$, $v \in T^*$. Let $p = A \rightarrow x \in P$ be a rule. Then, uAv directly derives uxv in the *rightmost way* according to p in G , written as

$$uAv \Rightarrow_{rm} uxv [p]$$

Note: We define \Rightarrow_{rm}^+ and \Rightarrow_{rm}^* by analogy with \Rightarrow^+ and \Rightarrow^* , respectively.

Rightmost Derivation: Example

$G = (N, T, P, \mathbf{E})$, where $N = \{E, F, T\}$, $T = \{i, +, *, (,)\}$,
 $P = \{$ 1: $E \rightarrow E+T$, 2: $E \rightarrow T$, 3: $T \rightarrow T*F$,
4: $T \rightarrow F$, 5: $F \rightarrow (E)$, 6: $F \rightarrow i$ $\}$

Rightmost derivation:

$$\begin{aligned} \underline{E} &\Rightarrow_{rm} E + \underline{T} && [1] \\ &\Rightarrow_{rm} E + T * \underline{F} && [3] \\ &\Rightarrow_{rm} E + \underline{T} * i && [6] \\ &\Rightarrow_{rm} E + \underline{F} * i && [4] \\ &\Rightarrow_{rm} \underline{E} + i * i && [6] \\ &\Rightarrow_{rm} \underline{T} + i * i && [2] \\ &\Rightarrow_{rm} \underline{F} + i * i && [4] \\ &\Rightarrow_{rm} i + i * i && [6] \end{aligned}$$

Derivation tree:

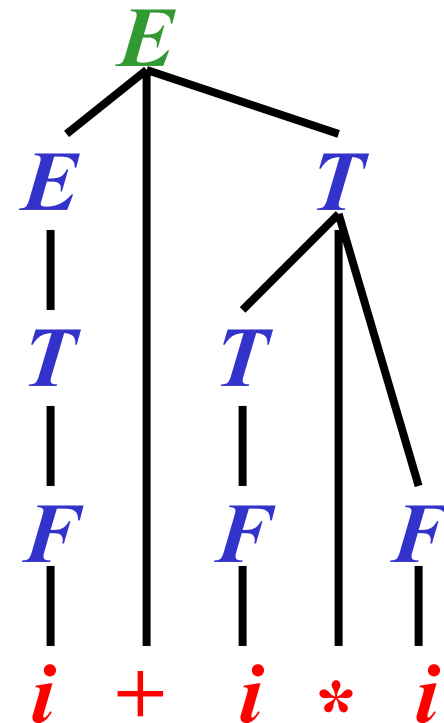

Derivations: Summary

- Let $A \rightarrow x \in P$ be a rule.
-

1) Derivation:

Let $u, v \in (N \cup T)^*$: $uAv \Rightarrow uxv$

Note: Any nonterminal is rewritten

2) Leftmost derivation:

Let $u \in T^*, v \in (N \cup T)^*$: $uAv \Rightarrow_{\text{lm}} uxv$

Note: Leftmost nonterminal is rewritten

3) Rightmost derivation:

Let $u \in (N \cup T)^*, v \in T^*$: $uAv \Rightarrow_{\text{rm}} uxv$

Note: Rightmost nonterminal is rewritten

Reduction of the Number of Derivations

Gist: Without any loss of generality, we can consider only leftmost or rightmost derivations.

Theorem: Let $G = (N, T, P, S)$ be a CFG. The next three languages coincide

$$(1) \{w: w \in T^*, S \Rightarrow_{lm}^* w\}$$

$$(2) \{w: w \in T^*, S \Rightarrow_{rm}^* w\}$$

$$(3) \{w: w \in T^*, S \Rightarrow^* w\} = L(G)$$

Introduction to Ambiguity

$G_{expr1} = (N, T, P, E)$, where

$N = \{E, F, T\}$, $T = \{i, +, *, (,)\}$,

$P = \{$
 1: $E \rightarrow E+T$, 2: $E \rightarrow T$,
 3: $T \rightarrow T*F$, 4: $T \rightarrow F$,
 5: $F \rightarrow (E)$, 6: $F \rightarrow i$
 $\}$

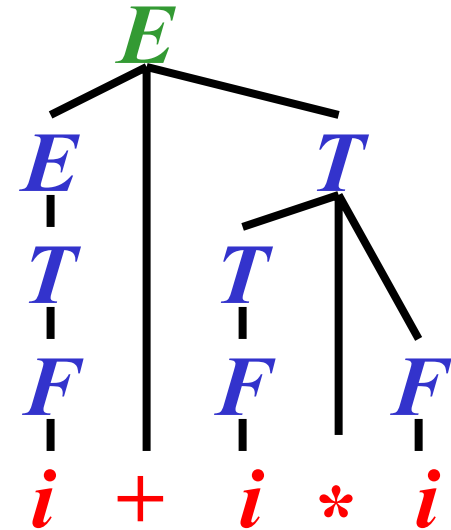

Theory: ☹️ × **Practice:** 😊

$G_{expr2} = (N, T, P, E)$, where

$N = \{E\}$, $T = \{i, +, *, (,)\}$,

$P = \{$
 1: $E \rightarrow E+E$, 2: $E \rightarrow E*E$,
 3: $E \rightarrow (E)$, 4: $E \rightarrow i$
 $\}$

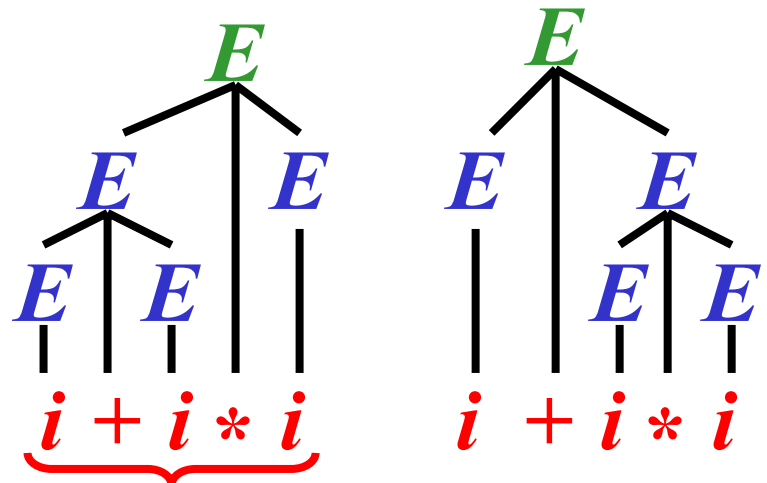

Theory: 😊 × **Practice:** ☹️

Note: $L(G_{expr1}) = L(G_{expr2})$

Improper during compilation

Grammatical Ambiguity

Definition: Let $G = (N, T, P, S)$ be a CFG. If there exists $x \in L(G)$ with more than one derivation tree, then G is *ambiguous*; otherwise, G is *unambiguous*.

Definition: A CFL, L , is *inherently ambiguous* if L is generated by no unambiguous grammar.

Example:

- G_{expr1} is **unambiguous**, because for every $x \in L(G_{expr1})$ there exists **only one derivation tree**
- G_{expr2} is **ambiguous**, because for $i+i*i \in L(G_{expr2})$ there exist **two derivation trees**
- $L_{expr} = L(G_{expr1}) = L(G_{expr2})$ is **not inherently ambiguous** because G_{expr1} is **unambiguous**

Pushdown Automata (PDA)

Gist: An FA extended by a pushdown store.

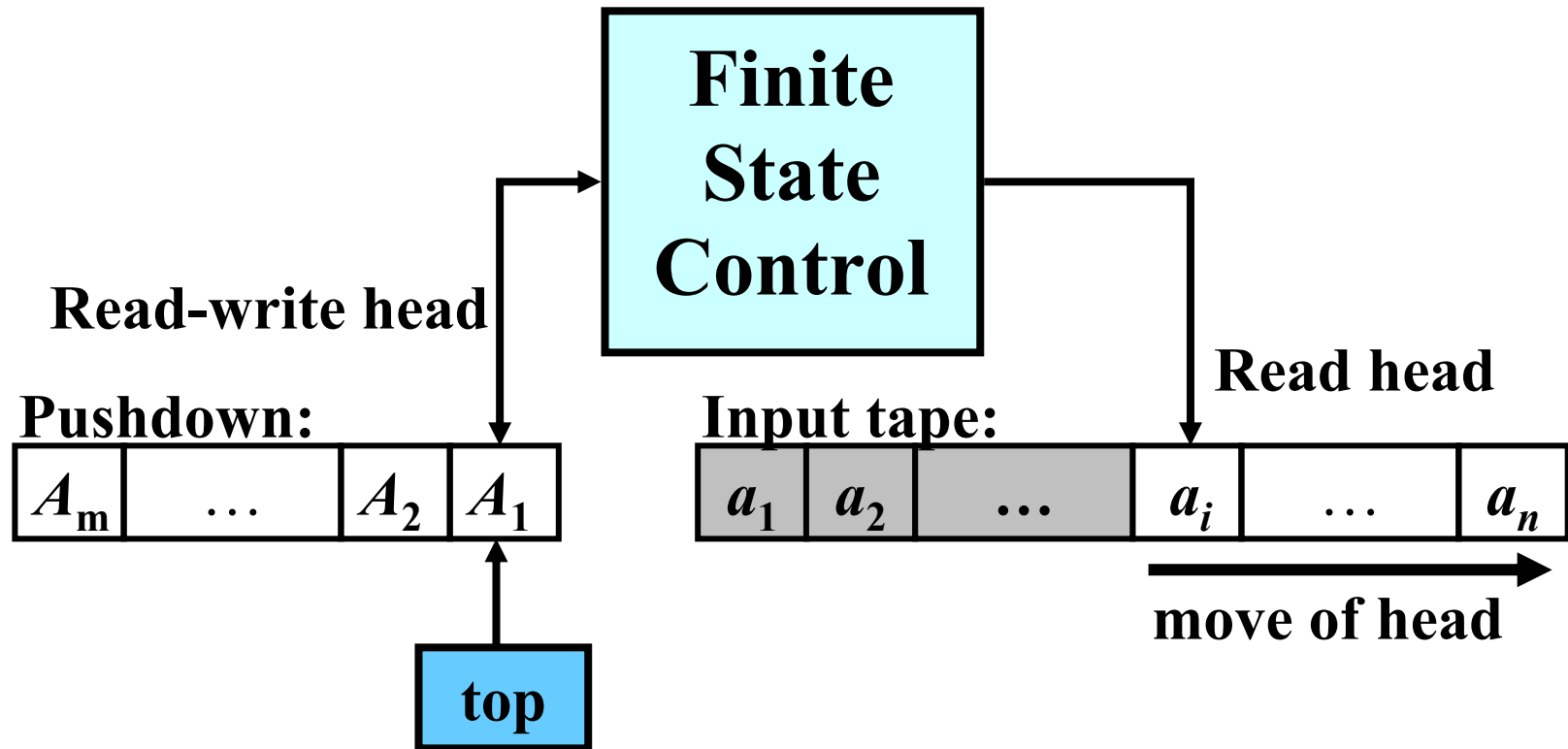

Pushdown Automata: Definition

Definition: *A pushdown automaton (PDA) is a 7-tuple $M = (Q, \Sigma, \Gamma, R, s, S, F)$, where*

- *Q is a finite set of states*
- *Σ is an input alphabet*
- *Γ is a pushdown alphabet*
- *R is a finite set of rules of the form: $Apa \rightarrow wq$ where $A \in \Gamma, p, q \in Q, a \in \Sigma \cup \{\varepsilon\}, w \in \Gamma^*$*
- *$s \in Q$ is the start state*
- *$S \in \Gamma$ is the start pushdown symbol*
- *$F \subseteq Q$ is a set of final states*

Notes on PDA Rules

Mathematical note on rules:

- Strictly mathematically, R is a relation from $\Gamma \times Q \times (\Sigma \cup \{\varepsilon\})$ to $\Gamma^* \times Q$
- Instead of $(Apa, wq) \in R$, however, we write $Apa \rightarrow wq \in R$

- **Interpretation of $Apa \rightarrow wq$:** if the current state is p , current input symbol is a , and the topmost symbol on the pushdown is A , then M can read a , replace A with w and change state p to q .
- **Note:** if $a = \varepsilon$, no symbol is read

Graphical Representation

 represents $q \in Q$

 represents the initial state $s \in Q$

 represents a final state $f \in F$

 denotes $Apa \rightarrow wq \in R$

Graphical Representation: Example

$M = (Q, \Sigma, \Gamma, R, s, S, F)$

where:

- $Q = \{s, p, q, f\}$;
- $\Sigma = \{a, b\}$;
- $\Gamma = \{a, S\}$;
- $R = \{Ssa \rightarrow Sap,$
 $apa \rightarrow aap,$
 $apb \rightarrow q,$
 $aqb \rightarrow q,$
 $Sq \rightarrow f\}$
- $F = \{f\}$

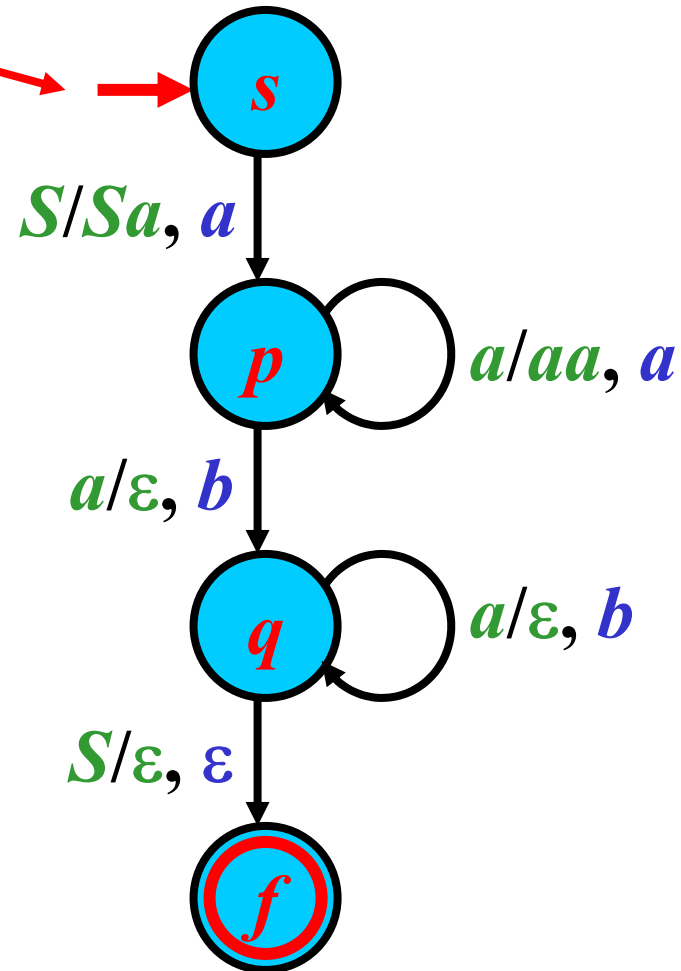

PDA Configuration

Gist: Instantaneous description of PDA

Definition: Let $M = (Q, \Sigma, \Gamma, R, s, S, F)$ be a PDA. A configuration of M is a string $\chi \in \Gamma^* Q \Sigma^*$

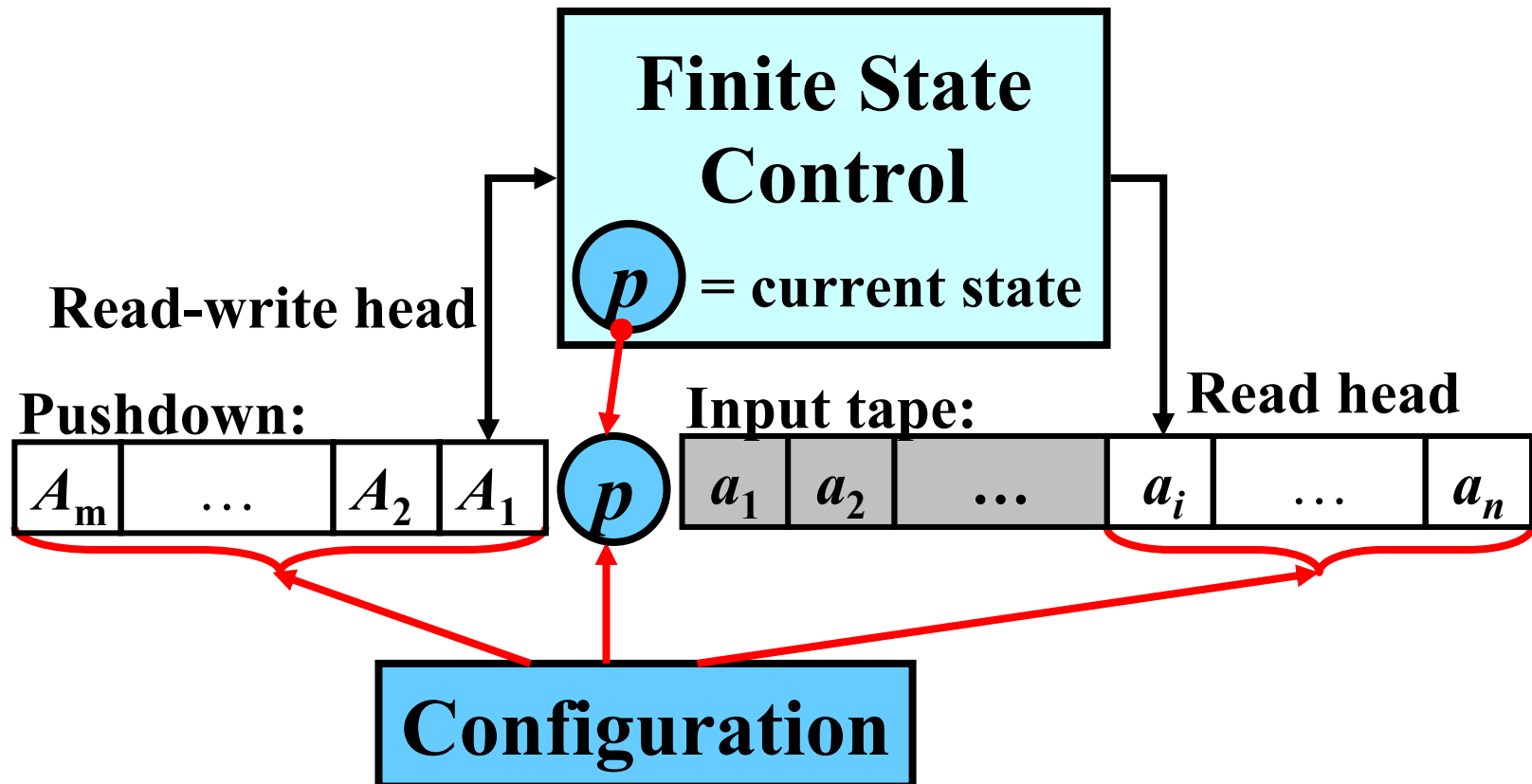

Move

Gist: A computational step made by a PDA

Definition: Let $xApay$ and $xwqy$ be two configurations of a PDA, M , where

$x, w \in \Gamma^*$, $A \in \Gamma$, $p, q \in Q$, $a \in \Sigma \cup \{\varepsilon\}$, and $y \in \Sigma^*$.

Let $r = Apa \rightarrow wq \in R$ be a rule. Then, M makes a *move* from $xApay$ to $xwqy$ according to r , written as $xApay \vdash xwqy [r]$ or, simply, $xApay \vdash xwqy$.

Note: if $a = \varepsilon$, no input symbol is read

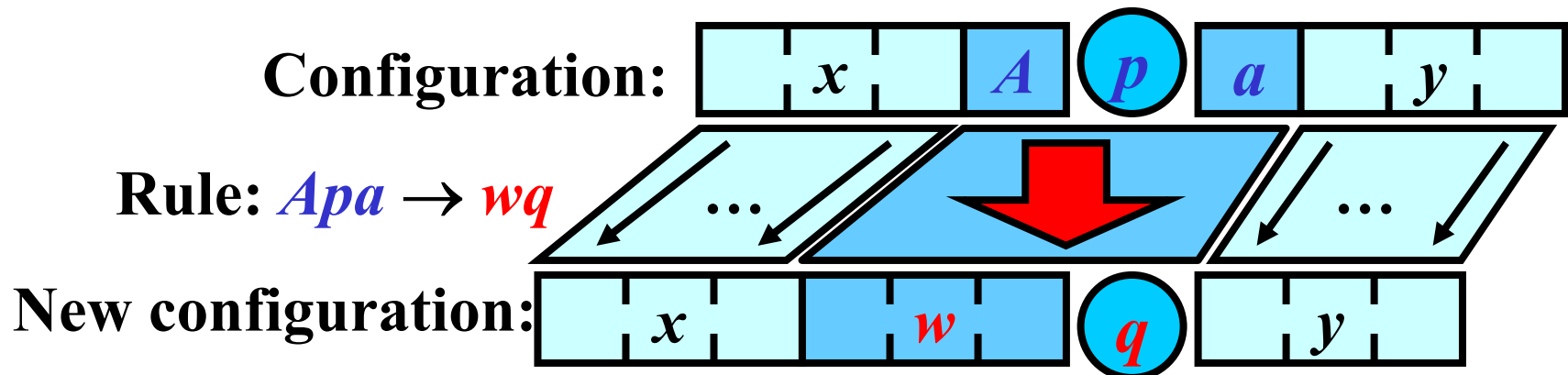

Sequence of Moves 1/2

Gist: Several consecutive computational steps

Definition: Let χ be a configuration. M makes *zero moves* from χ to χ ; in symbols,

$$\chi \vdash^0 \chi [\varepsilon] \text{ or, simply, } \chi \vdash^0 \chi$$

Definition: Let $\chi_0, \chi_1, \dots, \chi_n$ be a sequence of configurations, $n \geq 1$, and $\chi_{i-1} \vdash \chi_i [r_i]$, $r_i \in R$, for all $i = 1, \dots, n$; that is,

$$\chi_0 \vdash \chi_1 [r_1] \vdash \chi_2 [r_2] \dots \vdash \chi_n [r_n]$$

Then M makes n moves from χ_0 to χ_n ,

$$\chi_0 \vdash^n \chi_n [r_1 \dots r_n] \text{ or, simply, } \chi_0 \vdash^n \chi_n$$

Sequence of Moves 2/2

If $\chi_0 \vdash^{-n} \chi_n [\rho]$ for some $n \geq 1$, then
 $\chi_0 \vdash^{-+} \chi_n [\rho]$ or, simply, $\chi_0 \vdash^{-+} \chi_n$

If $\chi_0 \vdash^{-n} \chi_n [\rho]$ for some $n \geq 0$, then
 $\chi_0 \vdash^{-*} \chi_n [\rho]$ or, simply, $\chi_0 \vdash^{-*} \chi_n$

Example: Consider

$AApabc \vdash ABqbc$ [1: $Apa \rightarrow Bq$], and

$ABqbc \vdash ABCrc$ [2: $Bqb \rightarrow BCr$].

Then, $AApabc \vdash^{-2} ABCrc$ [1 2],

$AApabc \vdash^{-+} ABCrc$ [1 2],

$AApabc \vdash^{-*} ABCrc$ [1 2]

Accepted Language: Three Types

Definition: Let $M = (Q, \Sigma, \Gamma, R, s, S, F)$ be a PDA.

1) The *language that M accepts by final state*, denoted by $L(M)_f$, is defined as

$$L(M)_f = \{w: w \in \Sigma^*, Ssw \stackrel{*}{\vdash} zf, z \in \Gamma^*, f \in F\}$$

2) The *language that M accepts by empty pushdown*, denoted by $L(M)_\varepsilon$, is defined as

$$L(M)_\varepsilon = \{w: w \in \Sigma^*, Ssw \stackrel{*}{\vdash} zf, z = \varepsilon, f \in Q\}$$

3) The *language that M accepts by final state and empty pushdown*, denoted by $L(M)_{f\varepsilon}$, is defined as

$$L(M)_{f\varepsilon} = \{w: w \in \Sigma^*, Ssw \stackrel{*}{\vdash} zf, z = \varepsilon, f \in F\}$$

PDA: Example

$M = (Q, \Sigma, \Gamma, R, s, S, F)$

where:

- $Q = \{s, p, q, f\}$;
- $\Sigma = \{a, b\}$;
- $\Gamma = \{a, S\}$;
- $R = \{Ssa \rightarrow Sap,$
 $apa \rightarrow aap,$
 $apb \rightarrow q,$
 $aqb \rightarrow q,$
 $Sq \rightarrow f\}$
- $F = \{f\}$

Question: $aabb \in L(M)_{f\varepsilon}$?

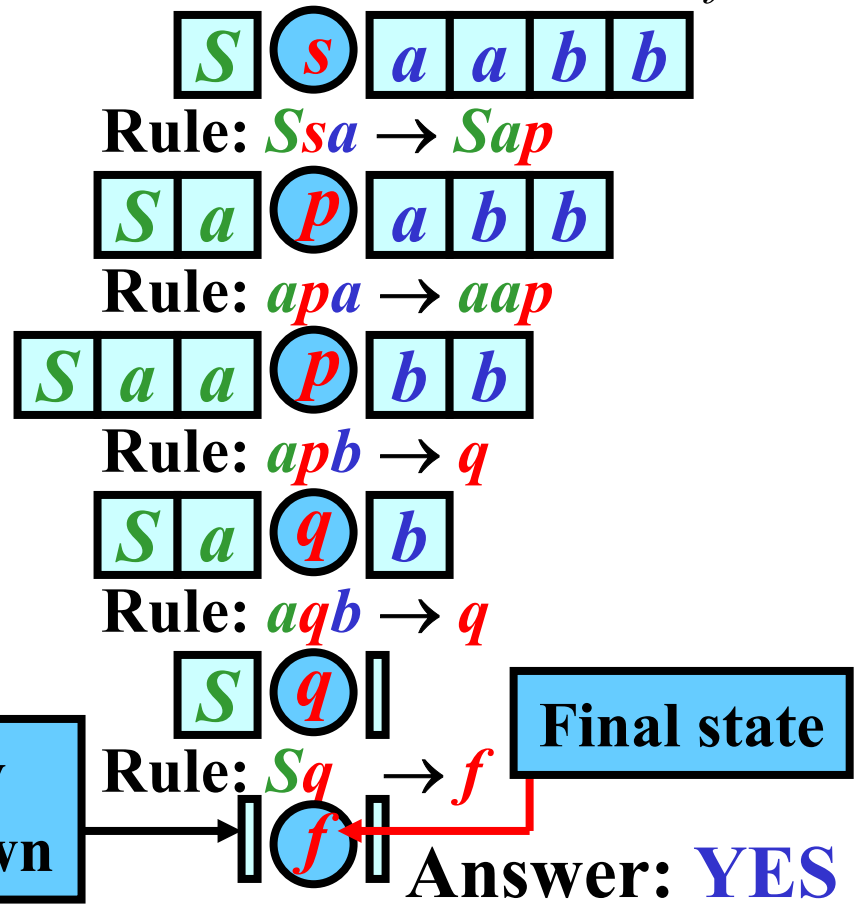

$Ssaabb \mid - Sapabb \mid - Saapbb \mid - Saqb \mid - Sq \mid - f$

Note: $L(M)_f = L(M)_\varepsilon = L(M)_{f\varepsilon} = \{a^n b^n : n \geq 1\}$

Three Types of Acceptance: Equivalence

Theorem:

- $L = L(M_f)_f$ for a PDA $M_f \Leftrightarrow L = L(M_{f\varepsilon})_{f\varepsilon}$ for a PDA $M_{f\varepsilon}$
- $L = L(M_\varepsilon)_\varepsilon$ for a PDA $M_\varepsilon \Leftrightarrow L = L(M_{f\varepsilon})_{f\varepsilon}$ for a PDA $M_{f\varepsilon}$
- $L = L(M_f)_f$ for a PDA $M_f \Leftrightarrow L = L(M_\varepsilon)_\varepsilon$ for a PDA M_ε

Note: There exist these conversions:

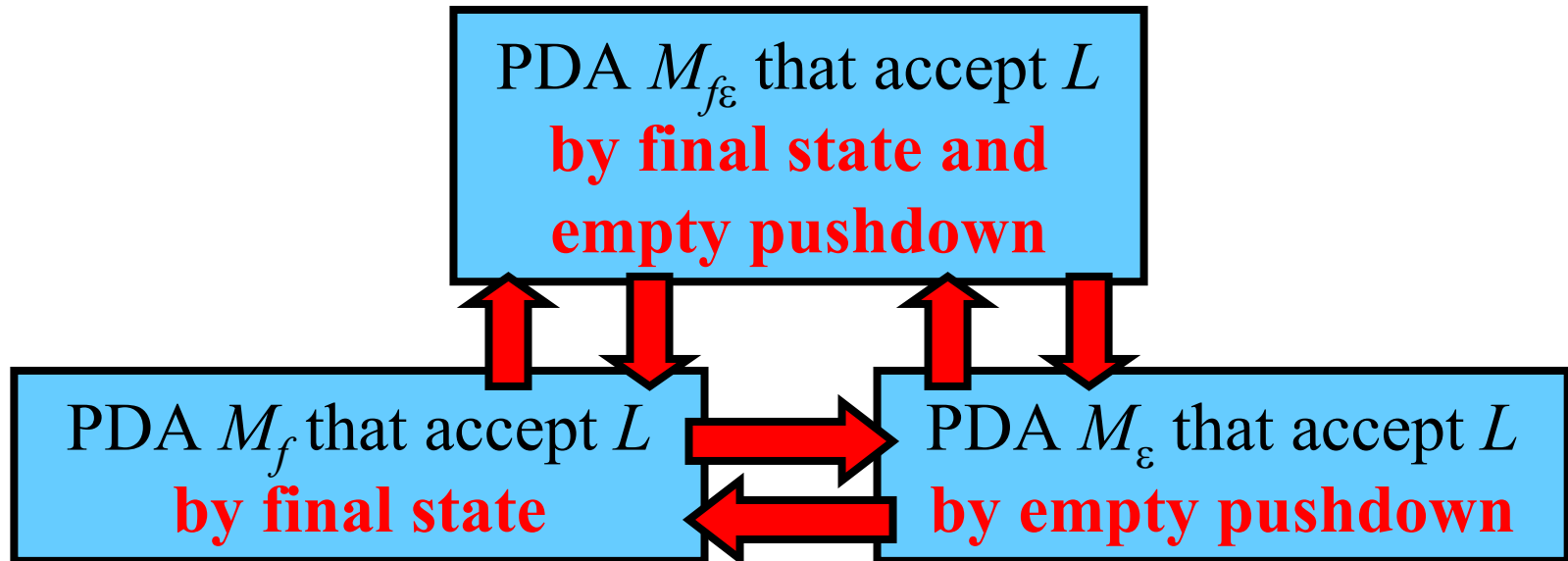

Deterministic PDA (DPDA)

Gist: Deterministic PDA makes no more than one move from any configuration.

Definition: Let $M = (Q, \Sigma, \Gamma, R, s, S, F)$ be a PDA. M is a *deterministic PDA* if for each rule $Apa \rightarrow wq \in R$, it holds that $R - \{Apa \rightarrow wq\}$ contains no rule with the left-hand side equal to Apa or Ap .

Illustration:

Configuration:



No more than one rule of the forms

$Ap \rightarrow w_1q_1$
 $Apa \rightarrow w_2q_2$

PDAs are Stronger than DPDAs

Theorem: There exists no DPDA M_{f_ε} that accepts
 $L = \{xy: x, y \in \Sigma^*, y = \text{reversal}(x)\}$

Proof: Omitted.

Illustration:

$$L = \{xy: x, y \in \Sigma^*, y = \text{reversal}(x)\}$$

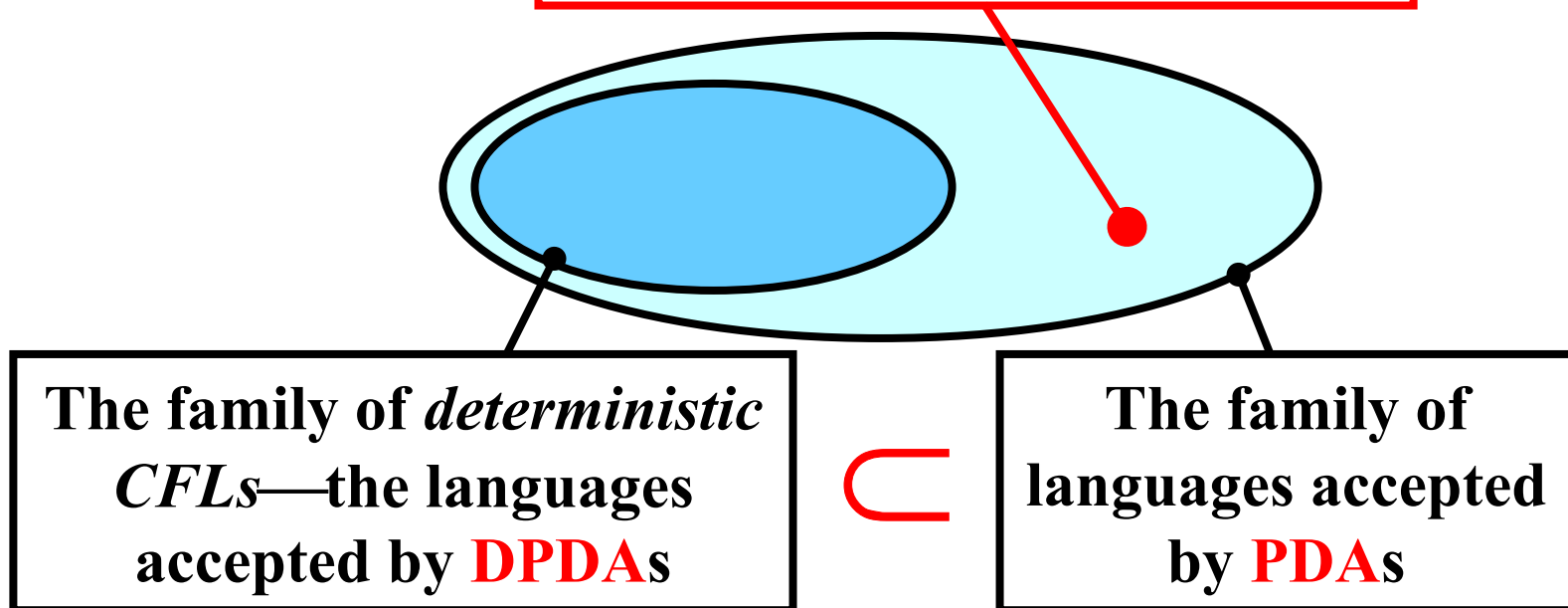

Extended PDA (EPDA)

Gist: The pushdown top of an EPDA represents a string rather than a single symbol.

Definition: *An Extended Pushdown automaton (EPDA) is a 7-tuple $M = (Q, \Sigma, \Gamma, R, s, S, F)$, where $Q, \Sigma, \Gamma, s, S, F$ are defined as in an PDA and R is a finite set of rules of the form: $\mathbf{v}pa \rightarrow wq$, where $\mathbf{v}, w \in \Gamma^*$, $p, q \in Q$, $a \in \Sigma \cup \{\varepsilon\}$*

Illustration:

Pushdown of PDA:

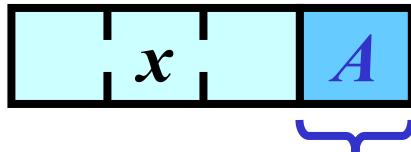

PDA has a **single symbols** as the pushdown top

Pushdown of EPDA:

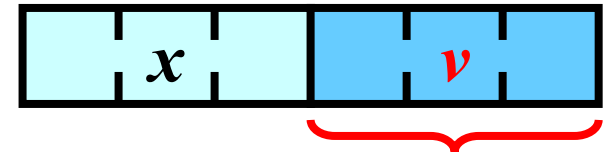

EPDA has a **string** as the pushdown top

Move in EPDA

Definition: Let $xvpay$ and $xwqy$ be two configurations of an EPDA, M , where $x, v, w \in \Gamma^*$, $p, q \in Q$, $a \in \Sigma \cup \{\varepsilon\}$, and $y \in \Sigma^*$. Let $r = vpa \rightarrow wq \in R$ be a rule. Then, M makes a *move* from $xvpay$ to $xwqy$ according to r , written as $xvpay \vdash xwqy [r]$ or $xvpay \vdash xwqy$.

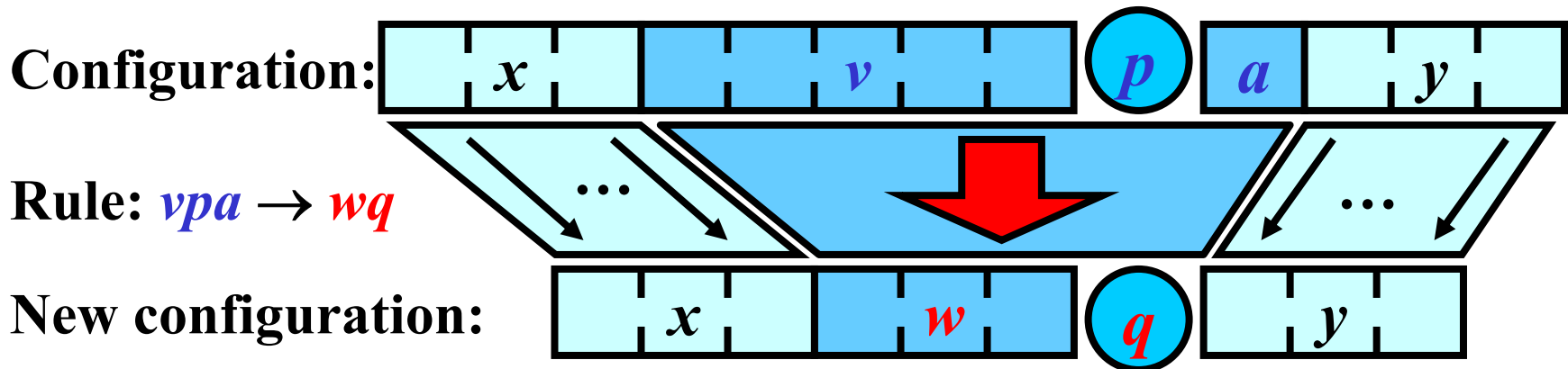

Note: \vdash^{-n} , \vdash^{+} , \vdash^{*} , $L(M)_f$, $L(M)_\varepsilon$, and $L(M)_{f\varepsilon}$ are defined analogically to the corresponding definitions for PDA.

EPDA: Example

$$M = (Q, \Sigma, \Gamma, R, s, S, F)$$

where:

- $Q = \{s, f\}$;
- $\Sigma = \{a, b\}$;
- $\Gamma = \{a, b, S, C\}$;
- $R = \left\{ \begin{array}{l} sa \rightarrow as, \\ sb \rightarrow bs, \\ s \rightarrow Cs, \\ aCsa \rightarrow Cs, \\ bCsb \rightarrow Cs, \\ SCs \rightarrow f \end{array} \right\}$
- $F = \{f\}$

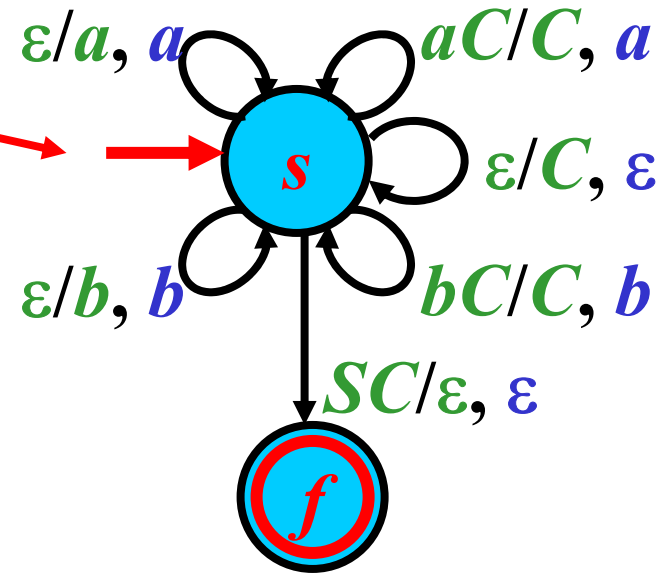

Question: $abba \in L_{f\varepsilon}(M)$?

$$\begin{array}{l} \underline{S}s\underline{ab}ba \mid - \underline{S}a\underline{s}b\underline{b}a \mid - \underline{S}a\underline{b}s\underline{b}a \\ \mid - \underline{S}a\underline{b}C\underline{s}b\underline{a} \mid - \underline{S}a\underline{C}s\underline{a} \\ \mid - \underline{S}C\underline{s} \mid - \underline{f} \end{array}$$

Answer: YES

Note: $L(M)_f = L(M)_\varepsilon = L(M)_{f\varepsilon} = \{xy : x, y \in \Sigma^*, y = \text{reversal}(x)\}$

Three Types of Acceptance: Equivalence

Theorem:

- $L = L(M_f)_f$ for an EPDA $M_f \Leftrightarrow L = L(M_{f\varepsilon})_{f\varepsilon}$ for an EPDA $M_{f\varepsilon}$
- $L = L(M_\varepsilon)_\varepsilon$ for an EPDA $M_\varepsilon \Leftrightarrow L = L(M_{f\varepsilon})_{f\varepsilon}$ for an EPDA $M_{f\varepsilon}$
- $L = L(M_f)_f$ for an EPDA $M_f \Leftrightarrow L = L(M_\varepsilon)_\varepsilon$ for an EPDA M_ε

Note: There exist these conversion:

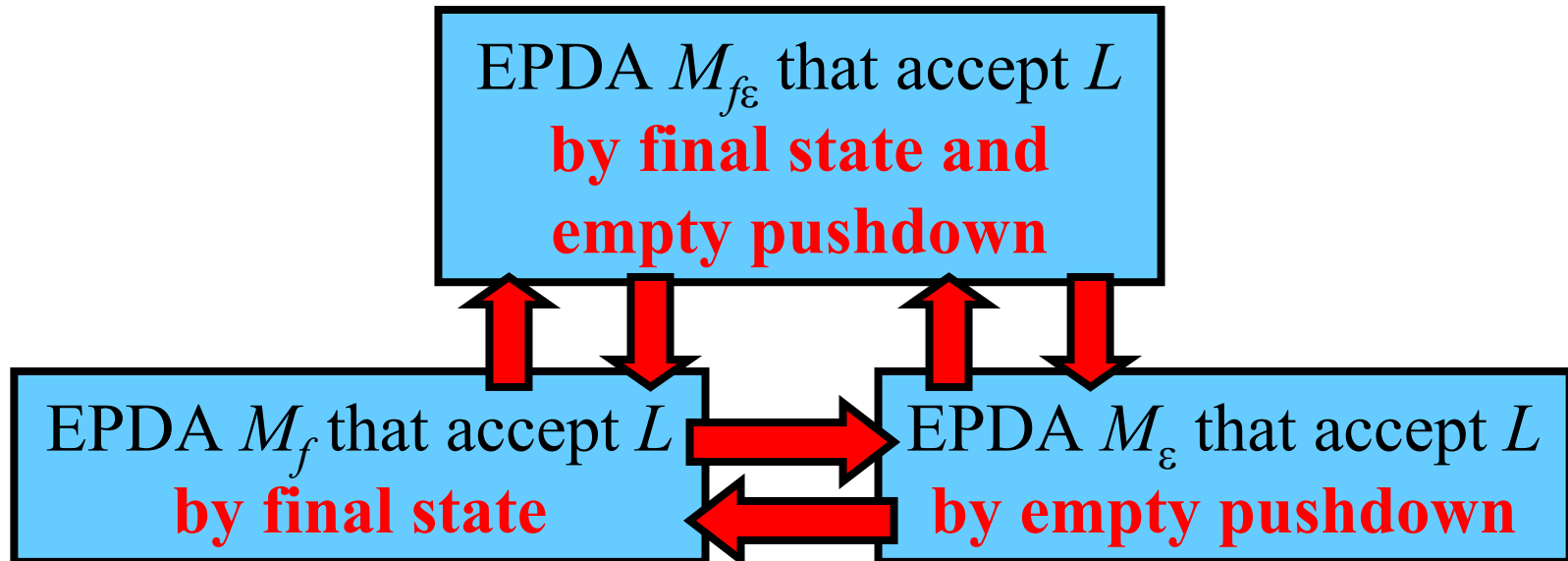

EPDAs and PDAs are Equivalent

Theorem: For every EPDA M , there is a PDA M' ,
and $L(M)_f = L(M')_f$.

Proof: Omitted.

Illustration:

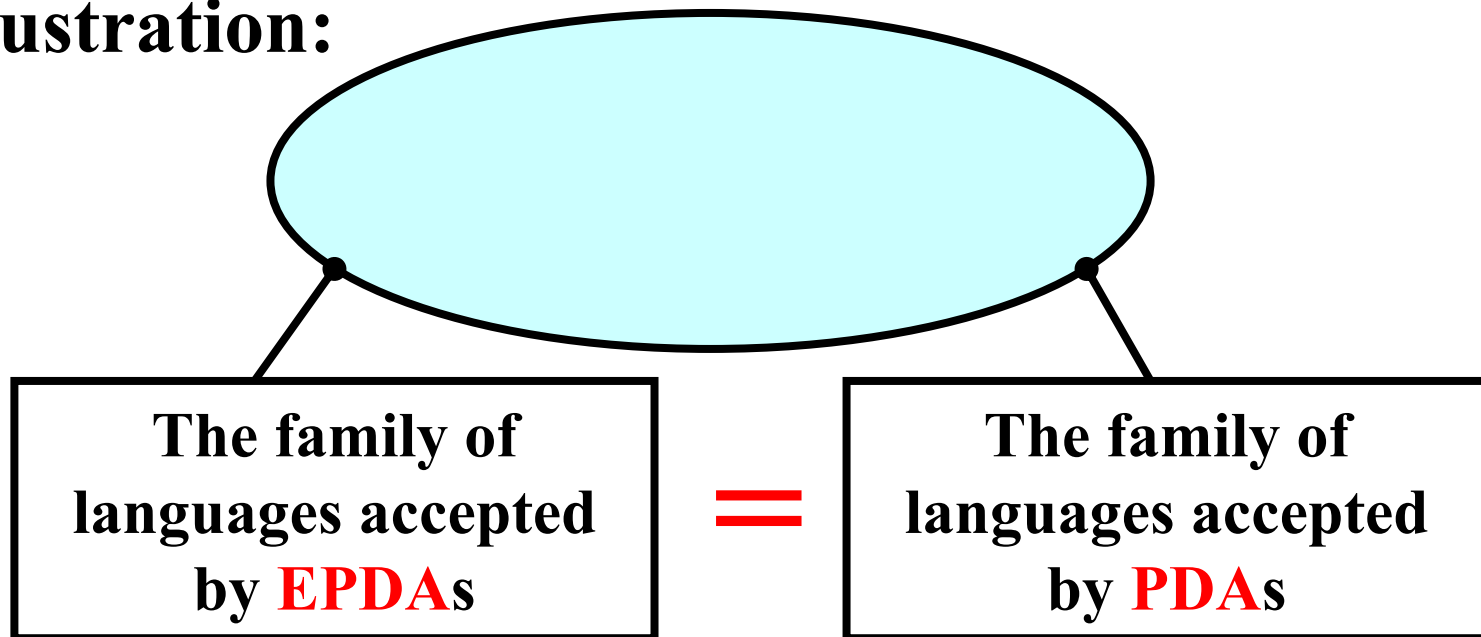

EPDAs and PDAs as Parsing Models for CFGs

Gist: An EPDA or a PDA can simulate the construction of a derivation tree for a CFG

• Two basic approaches:

1) Top-Down Parsing

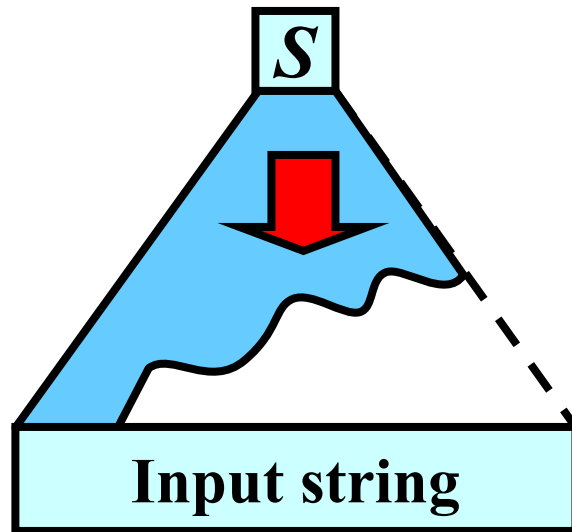

From S towards the input string

2) Bottom-Up Parsing

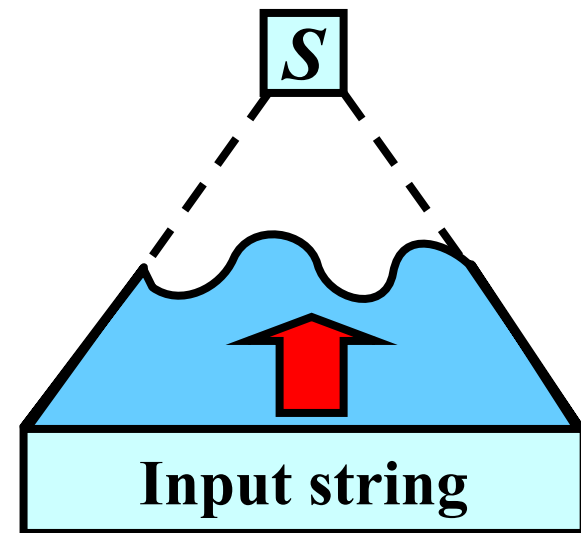

From the input string towards S

EPDAs as Models of Bottom-Up Parsers 1/2

Gist: An EPDA M underlies a bottom-up parser

1) M contains *shift* rules that copy the input symbols onto the pushdown:

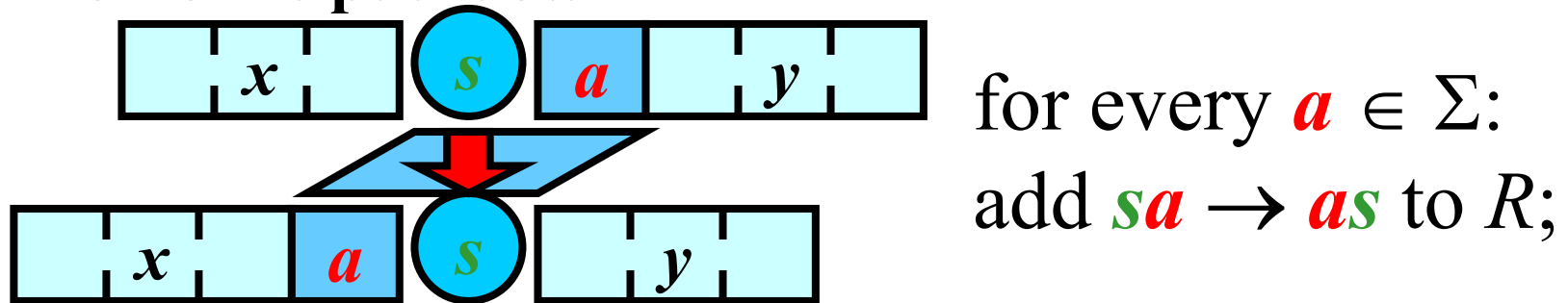

2) M contains *reduction* rules that simulate the application of a grammatical rule in reverse:

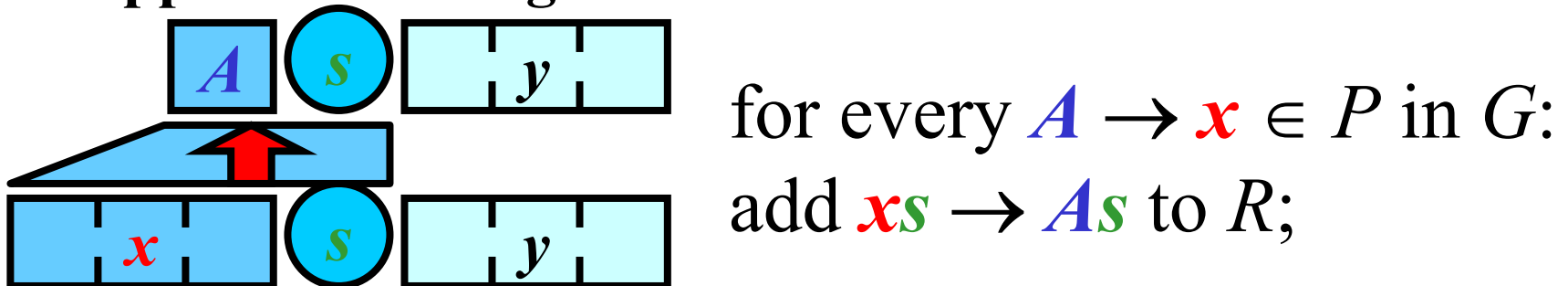

3) M also contains the rule $\#Ss \rightarrow f$ that takes M to a final state f

EPDAs as Models of Bottom-Up Parsers 2/2

Bottom-up construction of a derivation tree:

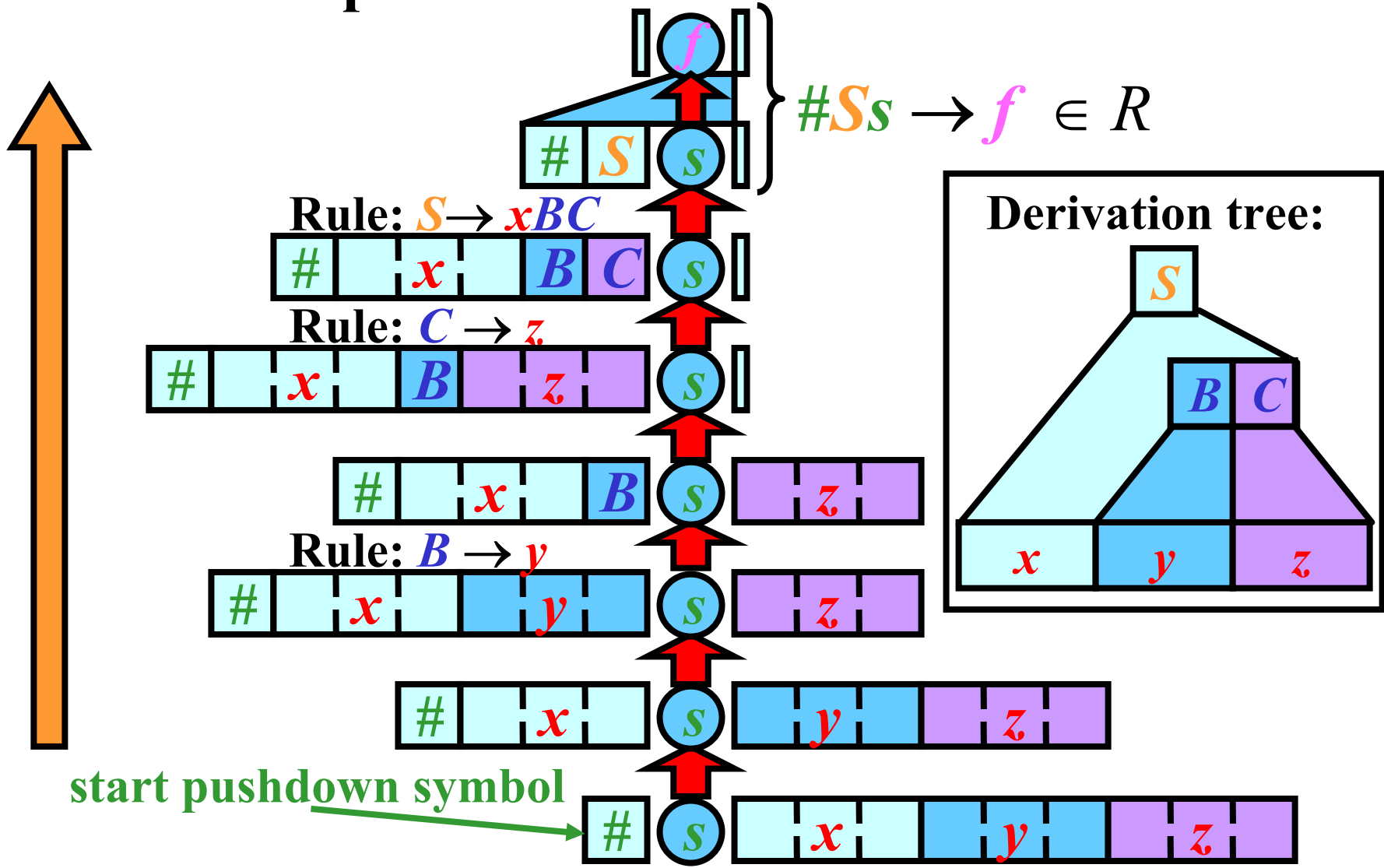

Algorithm: From CFG to EPDA

- **Input:** CFG $G = (N, T, P, S)$
 - **Output:** EPDA $M = (Q, \Sigma, \Gamma, R, s, \#, F)$; $L(G) = L(M)_f$
-
- **Method:**
 - $Q := \{s, f\}$;
 - $\Sigma := T$;
 - $\Gamma := N \cup T \cup \{\#\}$;
 - Construction of R :
 - for every $a \in \Sigma$, add $sa \rightarrow as$ to R ;
 - for every $A \rightarrow x \in P$, add $xs \rightarrow As$ to R ;
 - add $\#Ss \rightarrow f$ to R ;
 - $F := \{f\}$;

From CFG to EPDA: Example 1/2

- $G = (N, T, P, \mathbf{S})$, where:

$$N = \{\mathbf{S}\}, T = \{(\, , \,)\}, P = \{\mathbf{S} \rightarrow (\mathbf{S}), \mathbf{S} \rightarrow (\,)\}$$

Objective: An EPDA M such that $L(G) = L(M)_f$

$M = (Q, \Sigma, \Gamma, R, \mathbf{s}, \#, F)$ where:

$$Q = \{\mathbf{s}, \mathbf{f}\}; \Sigma = T = \{(\, , \,)\}; \Gamma = N \cup T \cup \{\#\} = \{\mathbf{S}, (\, , \,)\, \#}$$

$$R = \underbrace{\left\{ \mathbf{s}(\, \rightarrow (\mathbf{s}, \mathbf{s}) \rightarrow \right\}}_{\text{shift rules}}, \underbrace{\left\{ (\mathbf{S})\mathbf{s} \rightarrow \mathbf{S}\mathbf{s}, (\,)\mathbf{s} \rightarrow \mathbf{S}\mathbf{s}, \#\mathbf{S}\mathbf{s} \rightarrow \mathbf{f} \right\}}_{\text{reduction rules}}$$

$\begin{array}{cccc} \text{"("} \in T & \text{"("} \in T & \mathbf{S} \rightarrow (\mathbf{S}) \in P & \mathbf{S} \rightarrow (\,)\in P \\ \downarrow & \downarrow & \swarrow \searrow & \swarrow \searrow \\ \text{shift rules} & & \text{reduction rules} & \end{array}$

$$F = \{\mathbf{f}\}$$

From CFG to EPDA: Example 2/2

$M = (Q, \Sigma, \Gamma, R, s, \#, F)$, where:

$Q = \{s, f\}$, $\Sigma = T = \{(\, , \,)\}$, $\Gamma = \{(\, , \,), S, \#\}$, $F = \{f\}$

$R = \{s(\rightarrow (s, s) \rightarrow)s, (S)s \rightarrow Ss, ()s \rightarrow Ss, \#Ss \rightarrow f\}$

Question: $((\,)) \in L(M)_f?$

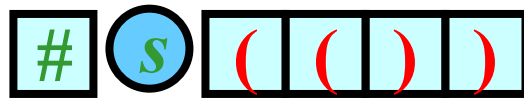

Rule: $s(\rightarrow (s$

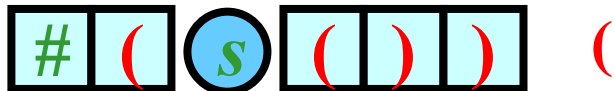

Rule: $s(\rightarrow (s$

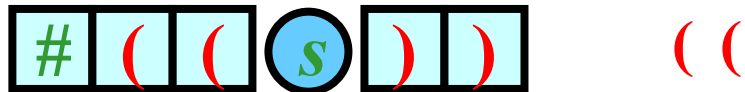

Rule: $s) \rightarrow)s$



Rule: $()s \rightarrow S$



Rule: $s) \rightarrow)s$



Rule: $(S) \rightarrow S$



Rule: $\#Ss \rightarrow f$



Answer: YES

PDAs as Models of Top-Down Parsers 1/2

Gist: An PDA M underlies a top-down parser

1) M contains *popping* rules that pops the top symbol from the pushdown and reads the input symbol if both coincide:

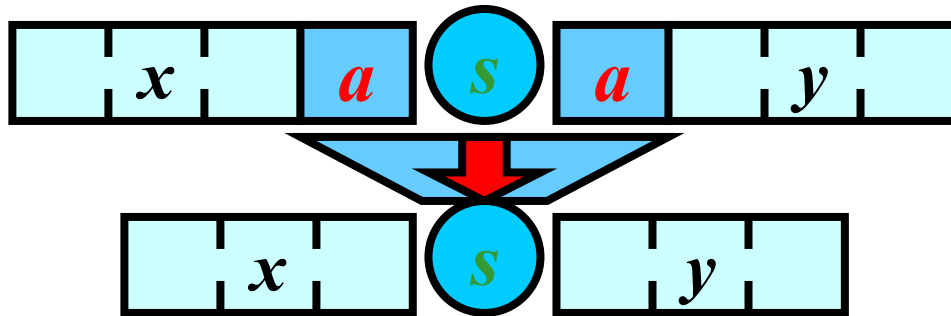

for every $a \in \Sigma$:
add $asa \rightarrow s$ to R ;

2) M contains *expansion* rules that simulate the application of a grammatical rule:

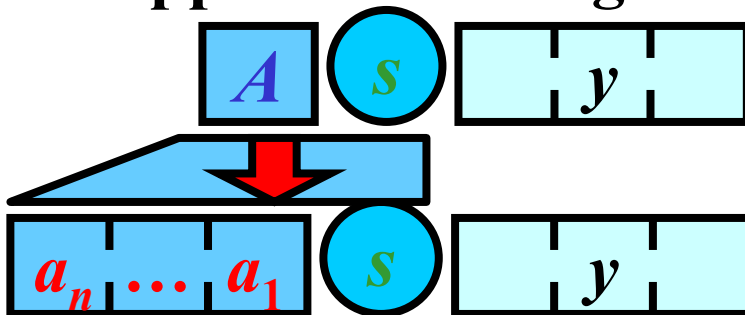

for every $A \rightarrow a_1 \dots a_n \in P$ in G ,
add $As \rightarrow \underbrace{a_n \dots a_1}_s$ to R ;
 $= \text{reversal}(a_1 \dots a_n)$

PDAs as Models of Top-Down Parsers 2/2

Top-down construction of a derivation tree:

start pushdown symbol

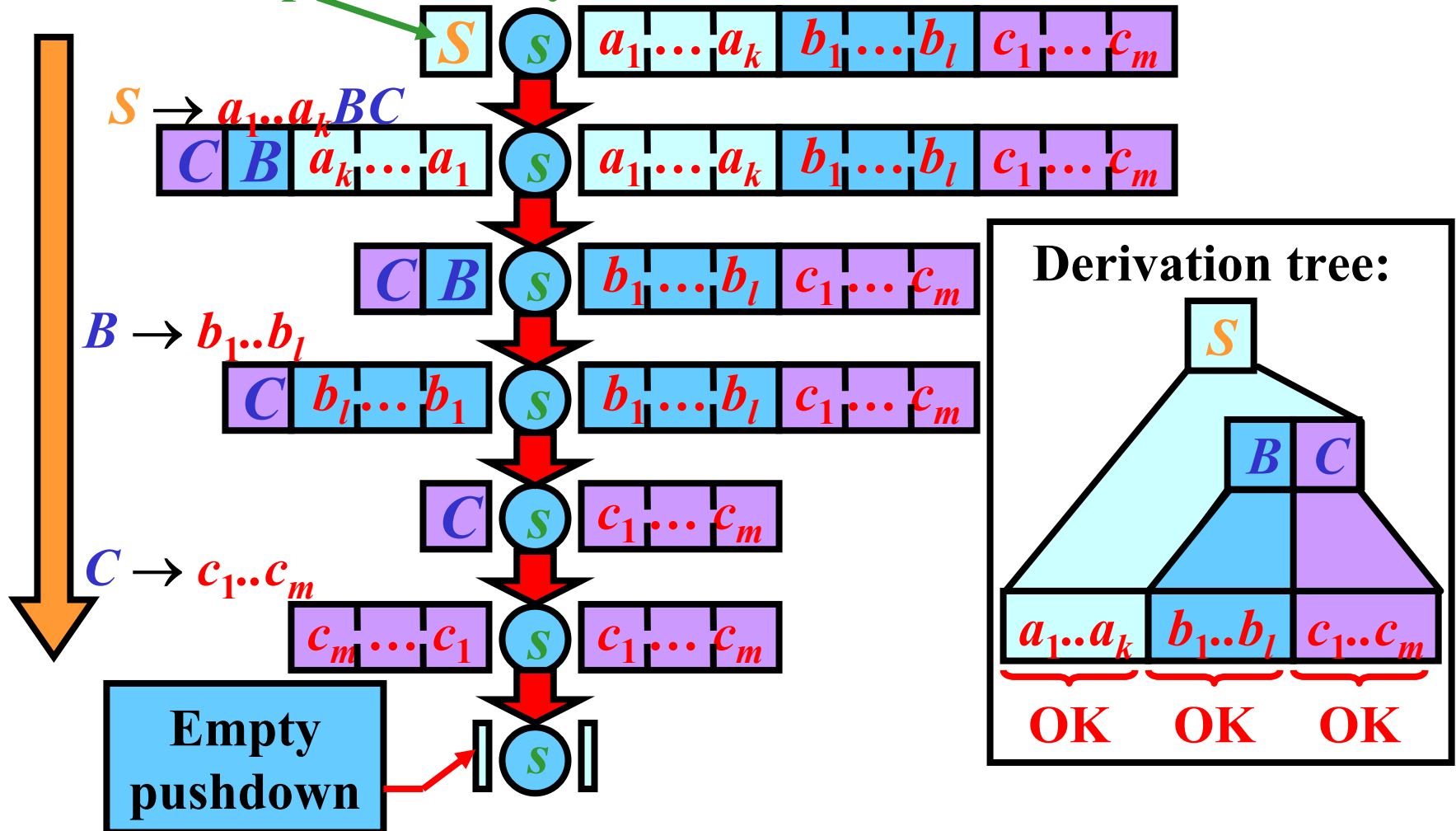

Algorithm: From CFG to PDA

- **Input:** CFG $G = (N, T, P, \mathbf{S})$
- **Output:** PDA $M = (Q, \Sigma, \Gamma, R, \mathbf{s}, \mathbf{S}, F)$; $L(G) = L(M)_\varepsilon$

- **Method:**
- $Q := \{\mathbf{s}\};$
- $\Sigma := T;$
- $\Gamma := N \cup T;$
- Construction of R :
 - for every $a \in \Sigma$, add $asa \rightarrow \mathbf{s}$ to R ;
 - for every $A \rightarrow \mathbf{x} \in P$, add $As \rightarrow \mathbf{y}\mathbf{s}$ to R ,
where $\mathbf{y} = \text{reversal}(\mathbf{x})$;
- $F := \emptyset;$

From CFG to PDA: Example 1/2

- $G = (N, T, P, \mathbf{S})$, where:

$$N = \{\mathbf{S}\}, T = \{(\,)\}, P = \{\mathbf{S} \rightarrow (\mathbf{S}), \mathbf{S} \rightarrow (\,)\}$$

Objective: An PDA M such that $L(G) = L(M)_\varepsilon$

$M = (Q, \Sigma, \Gamma, R, \mathbf{s}, \mathbf{S}, F)$ where:

$$Q = \{\mathbf{s}\}; \quad \Sigma = T = \{(\,)\}; \quad \Gamma = N \cup T = \{\mathbf{S}, (\,)\}$$

$$\text{"("} \in T \quad \text{")"} \in T \quad \mathbf{S} \rightarrow (\mathbf{S}) \in P \quad \mathbf{S} \rightarrow (\,) \in P$$

$$R = \underbrace{\{(\mathbf{s}(\rightarrow \mathbf{s}, \mathbf{)s}) \rightarrow \mathbf{s}, \mathbf{Ss} \rightarrow \mathbf{)S}(\mathbf{s}, \mathbf{Ss} \rightarrow \mathbf{)S}(\mathbf{s})\}}_{\text{popping rules}} \quad \underbrace{\{ \mathbf{Ss} \rightarrow \mathbf{)S}(\mathbf{s}, \mathbf{Ss} \rightarrow \mathbf{)S}(\mathbf{s}) \}}_{\text{expansion rules}}$$

$$F = \emptyset$$

From CFG to PDA: Example 2/2

$M = (Q, \Sigma, \Gamma, R, s, S, F)$, where:

$Q = \{s\}$, $\Sigma = T = \{(,)\}$, $\Gamma = \{(,), S\}$, $F = \emptyset$

$P = \{(s(\rightarrow s,)s) \rightarrow s, Ss \rightarrow)S(s, Ss \rightarrow)(s\}$

Question: $(()) \in L(M)_\varepsilon$?

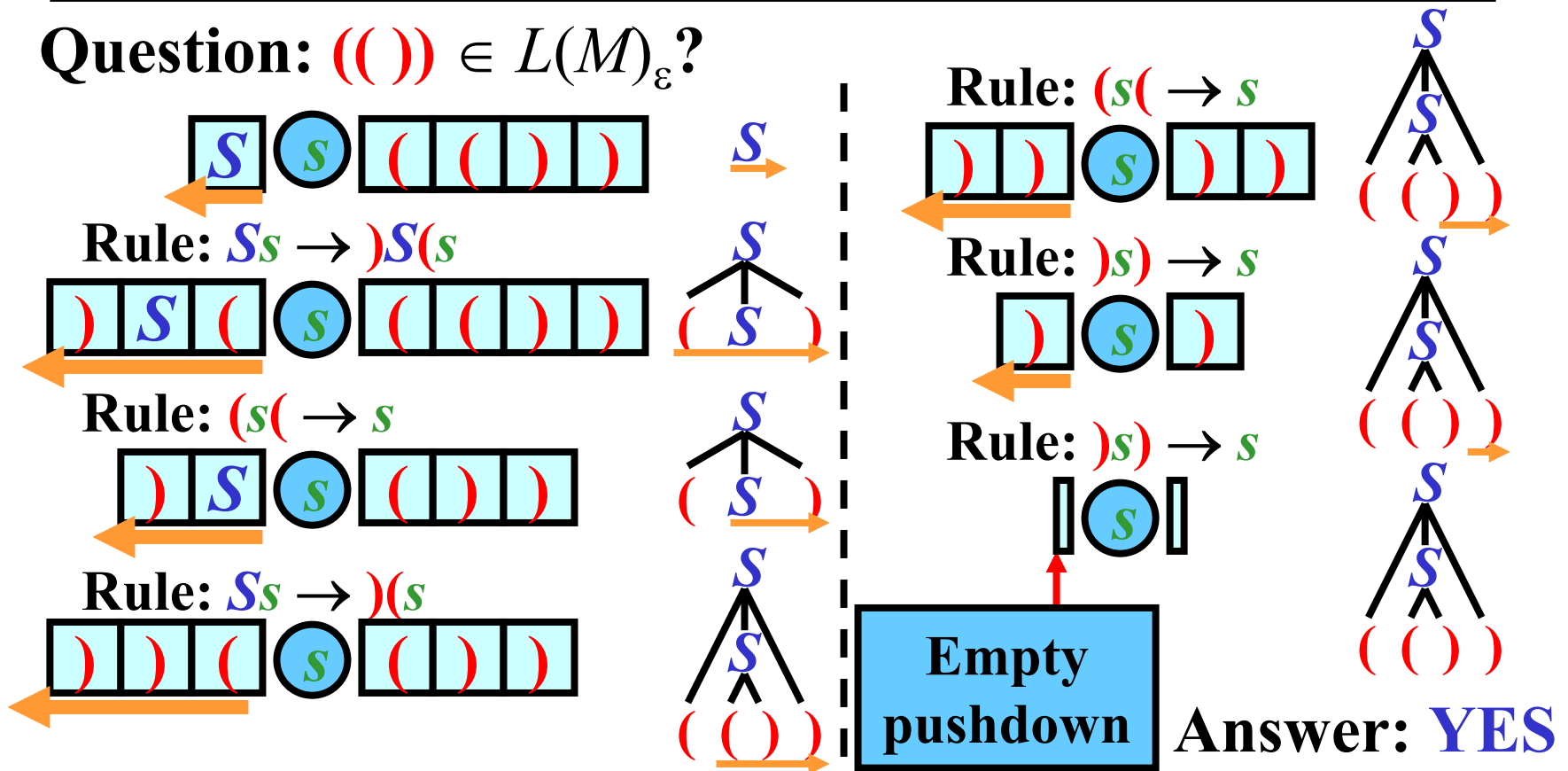

Models for Context-free Languages

Theorem: For every CFG G , there is an PDA M such that $L(G) = L(M)_\varepsilon$.

Proof: See the previous algorithm.

Theorem: For every PDA M , there is a CFG G such that $L(M)_\varepsilon = L(G)$.

Proof: Omitted.

Conclusion: The fundamental models for context-free languages are
1) **Context-free grammars** 2) **Pushdown automata**